

产品规格书

Specifcation of products

产品名称: 整流管模块

产品型号: MDK300A-Y03

浙江世菱半导体有限公司
ZHEJIANG SHILING SEMICONDUCTOR CO., LTD.

地址: 浙江省 丽水市 莲都区

电话: (0578) 3012571 3615078

传真: (0578) 3611180

邮编: 323000

E-mail: smrshiling01@163.com

Http://www.smrshiling.com

拟制	审核	核准
林益龙	曹剑龙	宗瑞

SYMBOL	CHARACTERISTIC	TEST CONDITIONS	T _j (°C)	VALUE			UNIT
				Min	Type	Max	
I _{F(AV)}	Mean forward current	180° half sine wave 50Hz Single side cooled, T _C =100°C	150			300	A
I _{F(RMS)}	RMS forward current	Single side cooled, T _C =100°C	150			471	A
V _{RRM}	Repetitive peak reverse voltage	V _{RRM} tp=10ms V _{RSM} = V _{DRM} &V _{RRM} +200V	150		1600		V
I _{RRM}	Repetitive peak current	at V _{RRM}	150			30	mA
I _{FSM}	Surge forward current	10ms half sine wave	150			10.0	KA
I ² t	I ² T for fusing coordination	V _R =0.6V _{RRM}					500
V _{FO}	Threshold voltage		150			0.75	V
r _F	Forward slope resistance						0.61
V _{FM}	Peak forward voltage	I _{FM} =900A	25			1.40	V
R _{th(j-c)}	Thermal resistance Junction to heatsink	At 180° sine Single side cooled				0.110	°C/W
V _{iso}	Isolation voltage	50Hz, RM. S, t=1min, I _{iso} : 1mA (max)		2500			V
F _m	Terminal connection torque(M6)					5.0	N.m
	Mounting torque(M8)					7.0	N.m
T _{stg}	Stored temperature			-40		125	°C
W _t	Weight					846	g
Outline							

OUTLINE DRAWING & CIRCUIT DIAGRAM

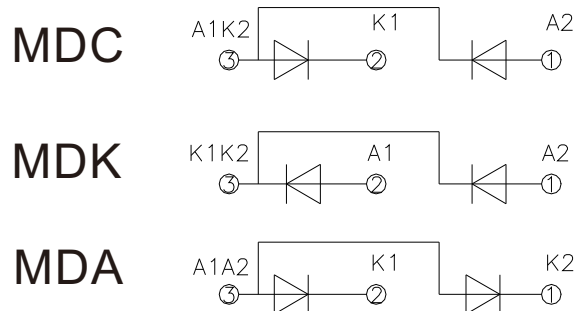

Rating and Characteristic

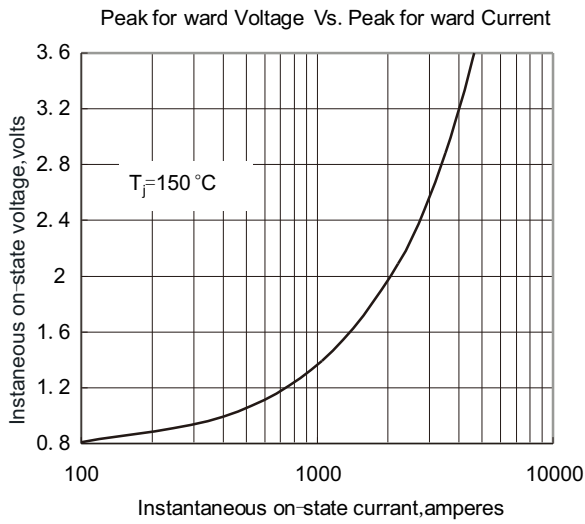

Fig. 1

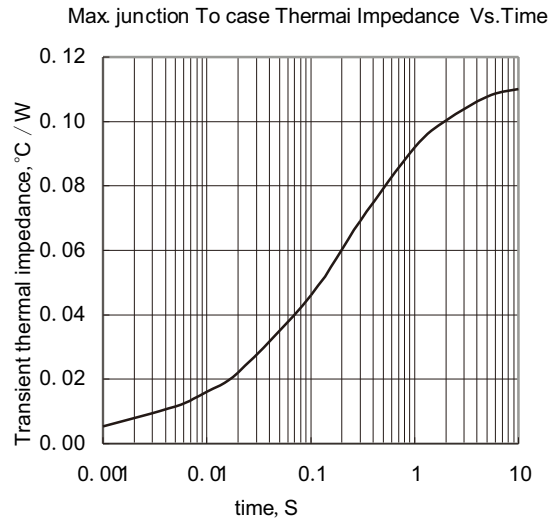

Fig. 2

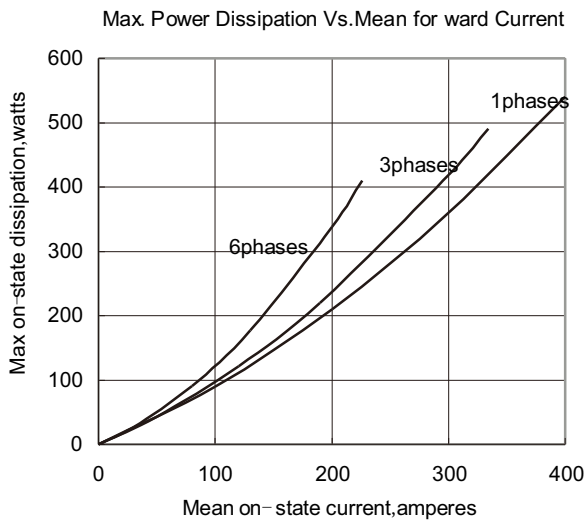

Fig. 3

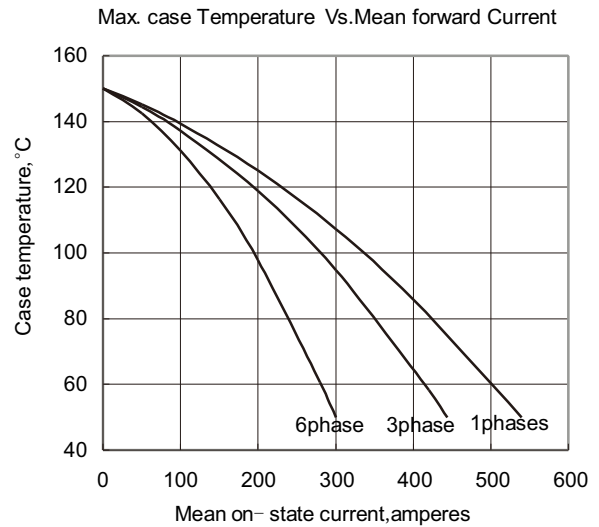

Fig. 4

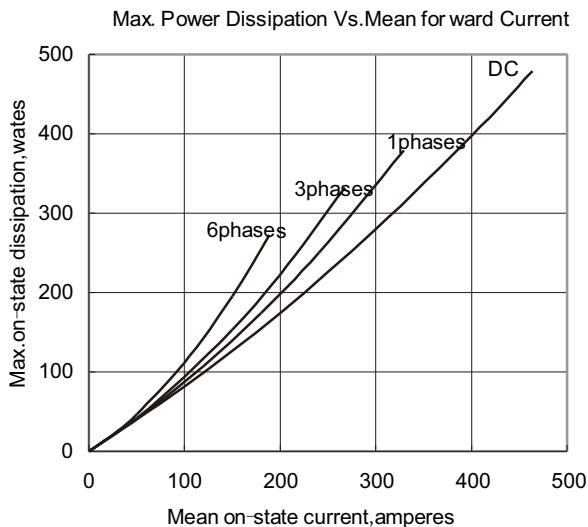

Fig. 5

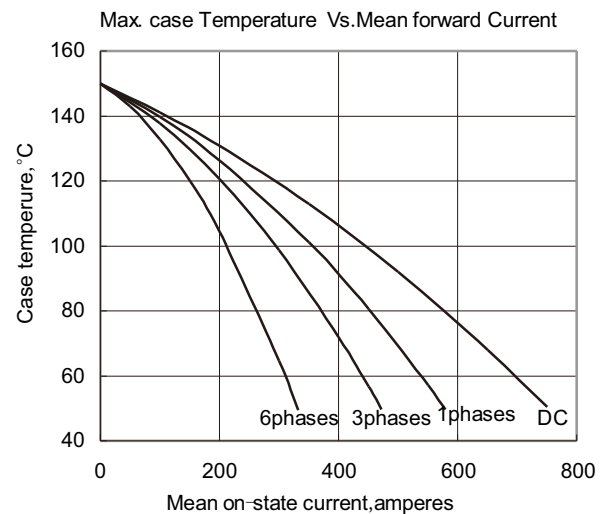

Fig. 6

Outside Dimension

