

产品规格书

Specification of Products

产品名称：平板型

产品型号：1600A

浙江世菱电力电子有限公司
ZHEJIANG SHILING POWER ELECTRON CO.,LTD.

厂址：浙江省 缙云县 五东工业区

电话：（0578）3012571 3615078

传真：（0578）3611180

邮编：321400

E-mail:smr@smrshiling.com

Http://www.smrshiling.com

拟制	审核	核准
丁国盛	曹剑龙	宗瑞

SYMBOL	CHARACTERISTIC	TEST CONDITIONS	T _j (C)	VALUE			UNIT	
				Min	Type	Max		
I _{F(AV)}	Mean forward current	180 half sine wave 50Hz Double side cooled, T _{FS} =55 C	150			2745	A	
I _{F(AV)}	Mean forward current	180 half sine wave 50Hz Double side cooled, T _{FS} =90 C	150			1990	A	
V _{RRM}	Repetitive peak reverse voltage	V _{RRM} tp=10ms V _{RSM} = V _{RRM} +100 V	150	2100		3000	V	
I _{RRM}	Repetitive peak current	at V _{RRM}	150			120	mA	
I _{FSM}	Surge forward current	10ms half sine wave	150			35.7	KA	
I ² T I	² T for fusing coordination	V _R =0.6V _{RRM}					6367	A ² s*10 ³
V _{FO}	Threshold voltage		150			0.92	V	
r _F	Forward slop resistance						0.12	mΩ
V _{FM}	Peak on-state voltage	T _M =4500A, F=28KN	150			1.46	V	
I _m	Reverse recovery current		150			150	A	
t _{rr}	Reverse recovery time	I _{TM} =1000A, tp=1000 s, di/dt=40A/s, V _R =50V					6.8	s
Q _{rr}	Recovery charge						522	C
R _{th(j-h)}	Thermal resistance Junction to heatsink	At 180° sine double side cooled Clamping force 28KN	150			0.020	C/W	
F _m	Mounting force			21		30	KN	
T _{stg}	Stored temperature			-40		160	C	
W _t	Weight				650		g	
Outline	ZT54cT60							

Outline

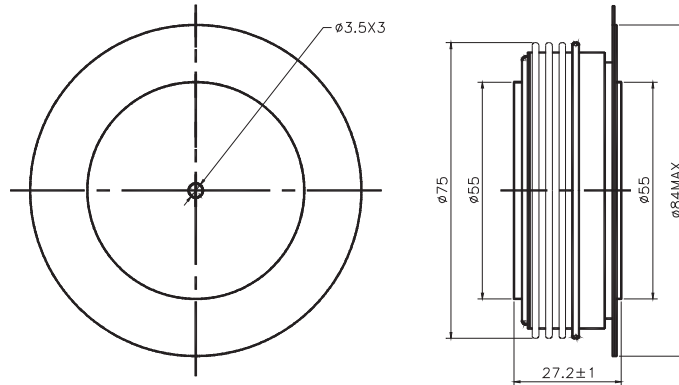

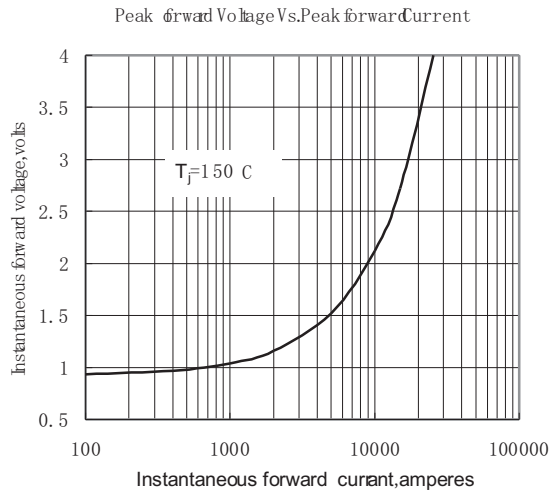

Fig. 1

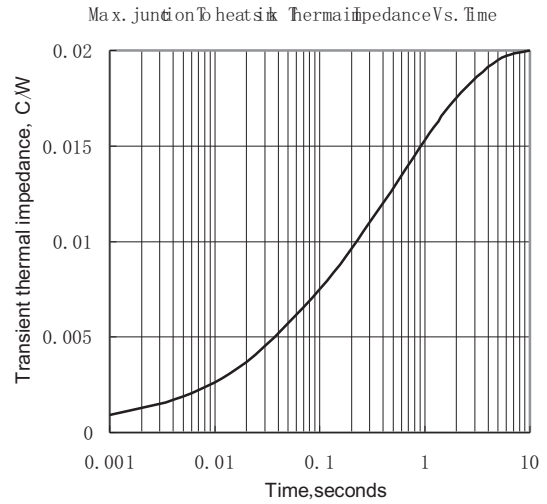

Fig. 2

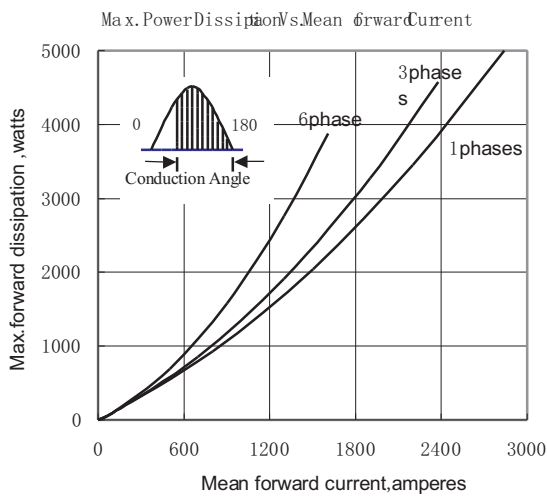

Fig. 3

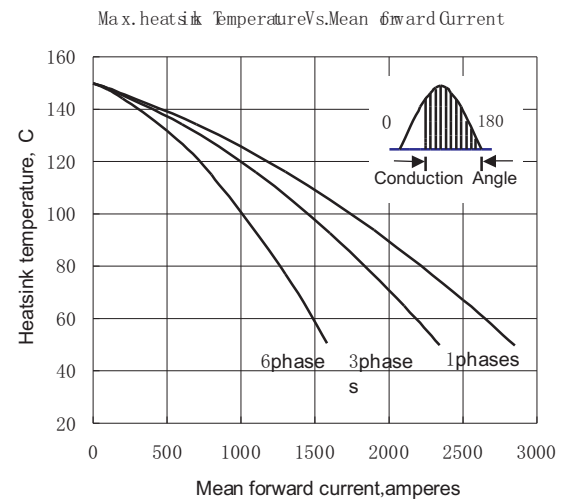

Fig. 4

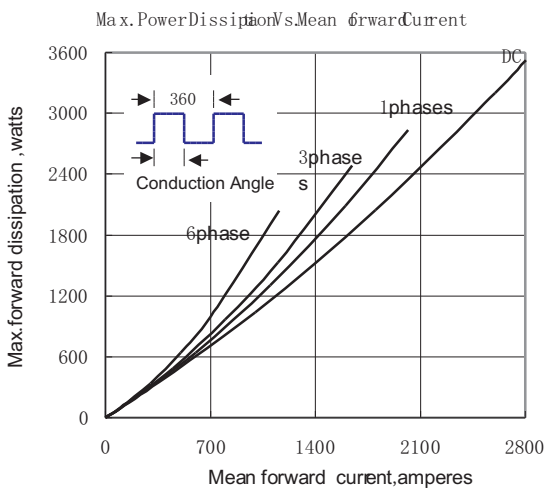

Fig. 5

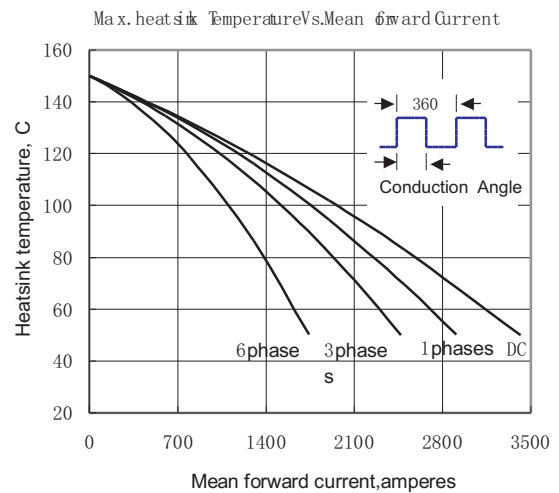

Fig. 6