

## 产品规格书

### Specification of Products

产品名称：平板型

产品型号：2500A

浙江世菱电力电子有限公司  
ZHEJIANG SHILING POWER ELECTRON CO.,LTD.

厂址：浙江省 缙云县 五东工业区

电话：（0578）3012571 3615078

传真：（0578）3611180

邮编：321400

E-mail:smr@smrshiling.com

Http://www.smrshiling.com

拟制	审核	核准
丁国盛	曹剑龙	宗瑞

SYMBOL	CHARACTERISTIC	TEST CONDITIONS	T <sub>j</sub> (C )	VALUE			UNIT	
				Min	Type	Max		
I <sub>F(AV)</sub>	Mean forward curent	180 half sinewave 50Hz Double side cooled, T <sub>CS</sub> =55 C	150			3835	A	
I <sub>F(AV)</sub>	Mean forward curent	180 half sinewave 50Hz Double side cooled, T <sub>CS</sub> =90 C	150			2846	A	
V <sub>RRM</sub>	Repetitive peak reverse voltage	V <sub>RRM</sub> tp=10ms V <sub>RSM</sub> = V <sub>RRM</sub> +100 V	150	3100		3800	V	
I <sub>RRM</sub>	Repetitive peak current	at V <sub>RRM</sub>	150			200	mA	
I <sub>FSM</sub>	Surge forward current	10ms half sine wave	150			49.9	KA	
I <sup>2</sup> T I	<sup>2</sup> T for fusing coordination	V <sub>R</sub> =0.6V <sub>RRM</sub>					12428	A <sup>2</sup> s*10 <sup>3</sup>
V <sub>FO</sub>	Threshold voltage		150			0.95	V	
r <sub>F</sub>	Forward slop resistance						0.14	mΩ
V <sub>FM</sub>	Peak on-state vtagel	T <sub>M</sub> =5400A, F=40KN	150			1.70	V	
I <sub>m</sub>	Reverse recovery current		150			150	A	
t <sub>rr</sub>	Reverse recovery time	I <sub>TM</sub> =1000A, tp= 1000 s, di/dt=-40A/s, V <sub>R</sub> =50V					8.0	s
Q <sub>rr</sub>	Recovery charge						600	C
R <sub>th(j-h)</sub>	Thermal resistance Junction to heatsink	At 180 <sup>0</sup> sine double side cooled Clamping force 40KN				0.011	C/W	
F <sub>m</sub>	Mounting force			35		47	KN	
T <sub>stg</sub>	Stored temperature			-40		160	C	
W <sub>t</sub>	Weight				1100		g	
Outline	ZT73cT							

Outline

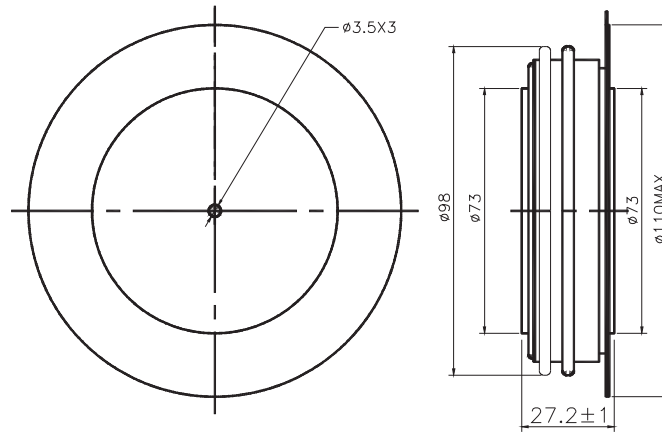

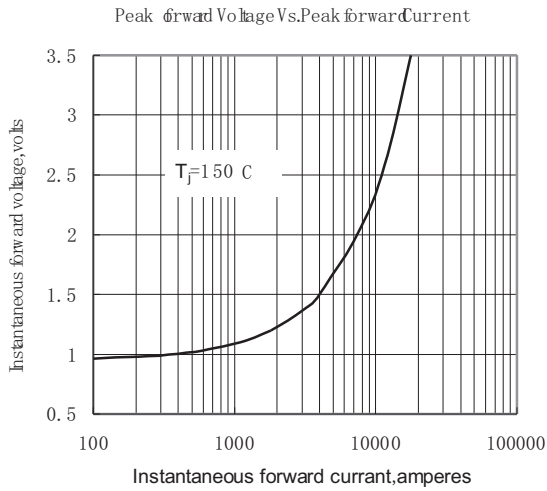

Fig. 1

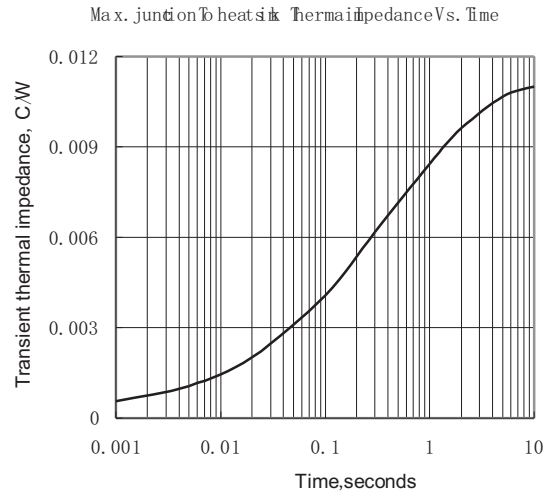

Fig. 2

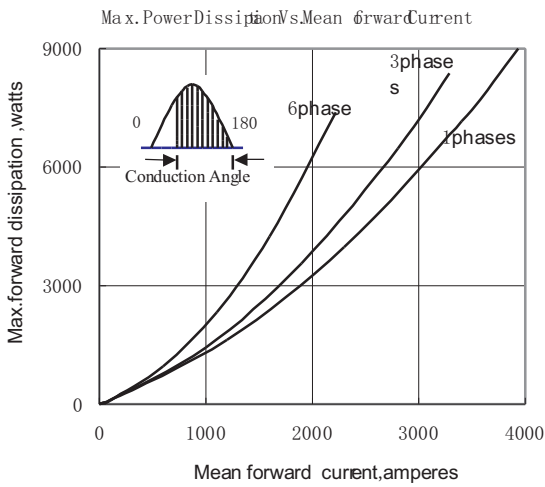

Fig. 3

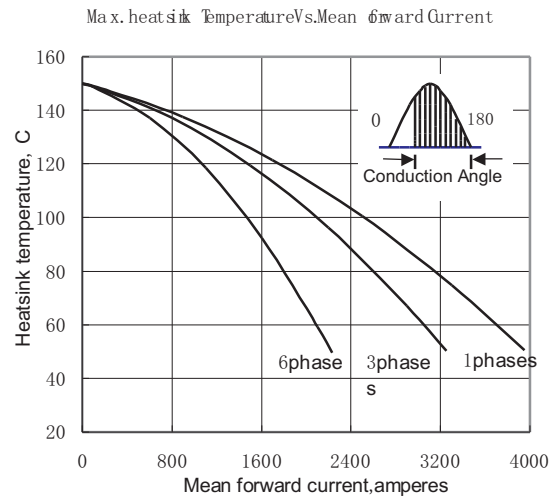

Fig. 4

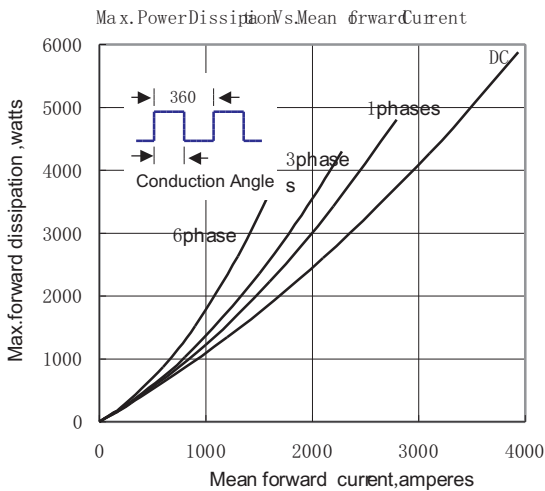

Fig. 5

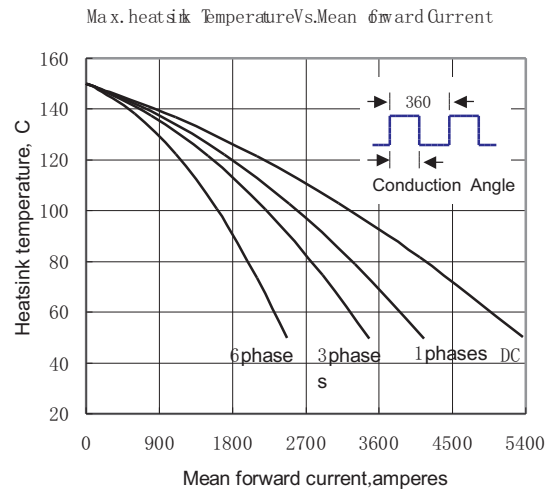

Fig. 6