

## 产品规格书

### Specifcation of products

产品名称: 三相整流模块

产品型号: MDS75A-T12-1

浙江世菱半导体有限公司  
ZHEJIANG SHILING SEMICONDUCTOR CO., LTD.

地址: 浙江省 丽水市 莲都区

电话: (0578) 3012571 3615078

传真: (0578) 3611180

邮编: 323000

E-mail: smrshiling01@163.com

Http://www.smrshiling.com

拟制	审核	核准
林益龙	曹剑龙	宗瑞

SYMBOL	CHARACTERISTIC	TEST CONDITIONS	T <sub>j</sub> (°C)	VALUE			UNIT
				Min	Type	Max	
I <sub>o</sub>	DC output current	Three-phase full wave rectifying circuit, T <sub>c</sub> =100 °C	150			75	A
V <sub>RRM</sub>	Repetitive peak reverse voltage	V <sub>RRM</sub> tp=10ms V <sub>RSM</sub> = V <sub>DRM</sub> &V <sub>RRM</sub> +200V	150	600		2200	V
I <sub>RRM</sub>	Repetitive peak current	at V <sub>RRM</sub>	150			8	mA
I <sub>FSM</sub>	Surge forward current	10ms half sine wave	150			0.8	KA
I <sup>2</sup> t	I <sup>2</sup> T for fusing coordination	V <sub>R</sub> =0.6V <sub>RRM</sub>				3.2	A <sup>2</sup> s*10 <sup>3</sup>
V <sub>FO</sub>	Threshold voltage		150			0.80	V
r <sub>F</sub>	Forward slop resistance					7.0	mΩ
V <sub>FM</sub>	Peak forward voltage	I <sub>FM</sub> =75A	25			1.1	V
R <sub>th(j-c)</sub>	Thermal resistance Junction to heatsink	Single side cooled				0.320	°C /W
V <sub>iso</sub>	Isolation voltage	50Hz, RM. S, t=1min, I <sub>iso</sub> : 1mA (max)		2500			V
F <sub>m</sub>	Terminal connection torque (M5)				4.0		N.m
	Mounting torque (M6)				5.0		N.m
T <sub>stg</sub>	Stored temperature			-40		125	°C
W <sub>t</sub>	Weight				154		g
Outline							

### OUTLINE DRAWING & CIRCUIT DIAGRAM

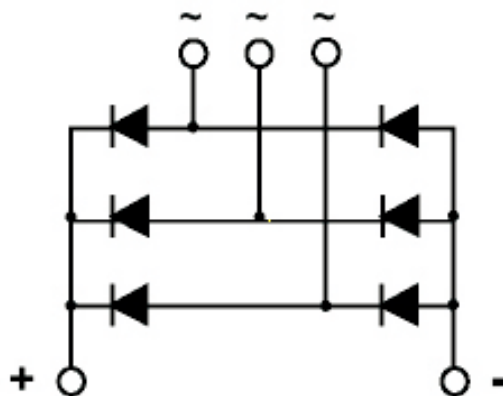

### Rating and Characteristic

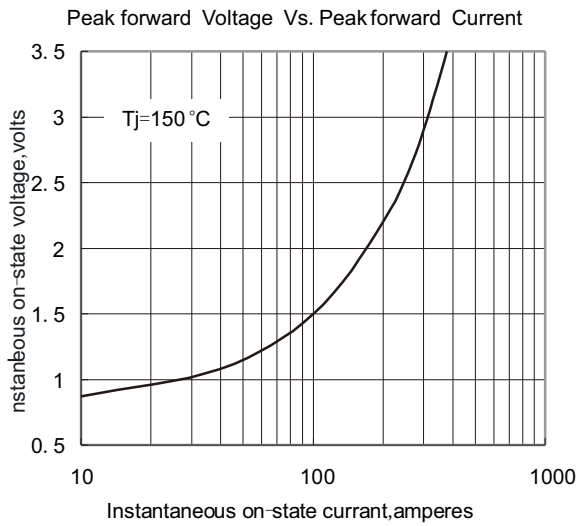

Fig. 1

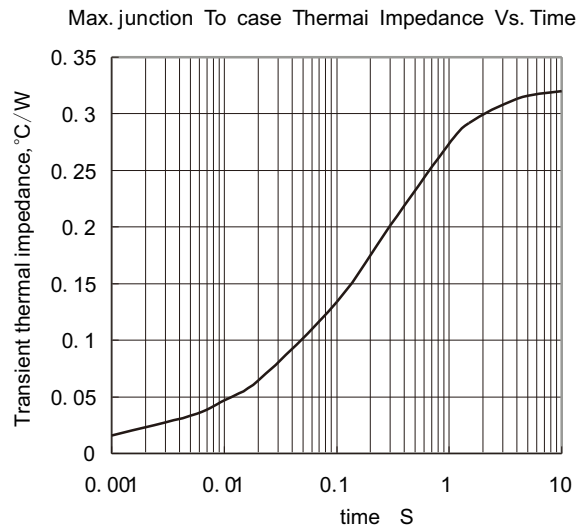

Fig. 2

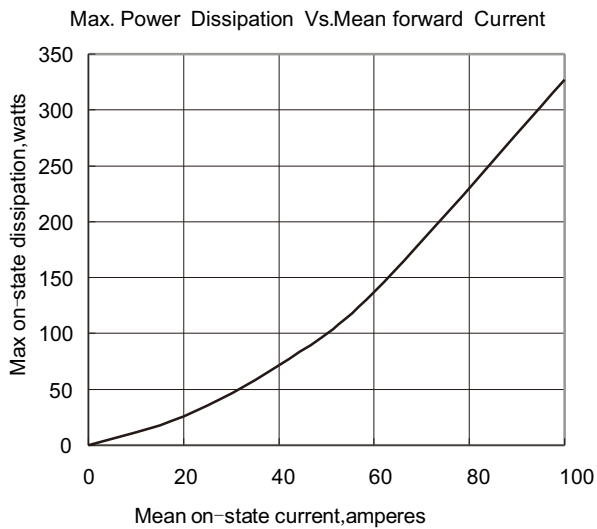

Fig. 3

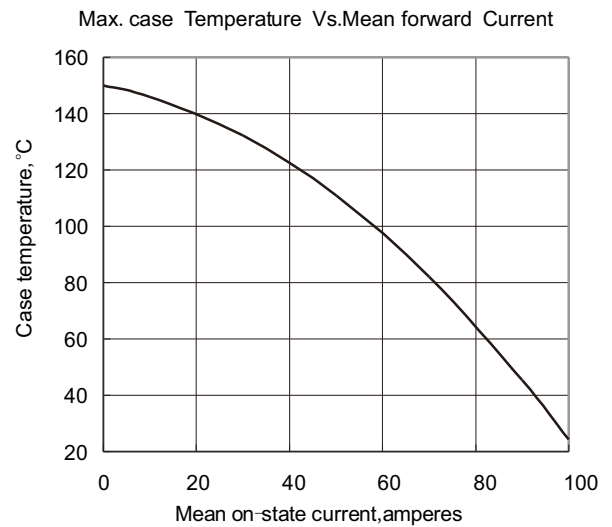

Fig. 4

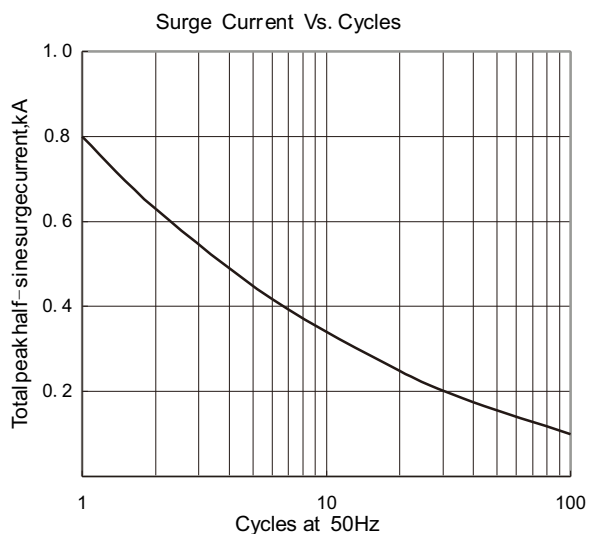

Fig. 5

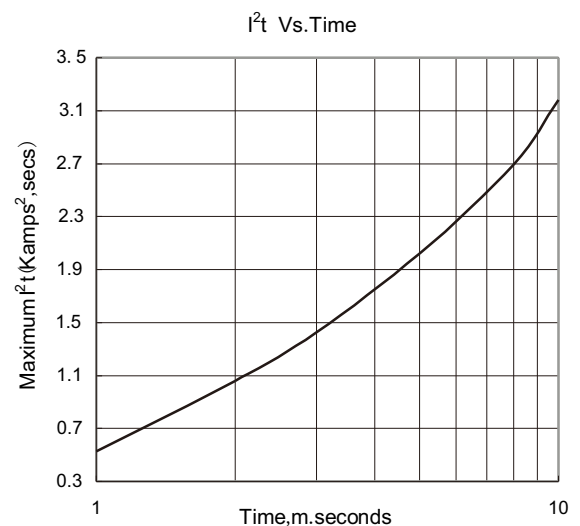

Fig. 6

### Outside Dimension

