

产品规格书

Specifcation of products

产品名称: 三相整流桥模块

产品型号: MDS50A-T15-1

浙江世菱半导体有限公司
ZHEJIANG SHILING SEMICONDUCTOR CO., LTD.

地址: 浙江省 丽水市 莲都区

电话: (0578) 3012571 3615078

传真: (0578) 3611180

邮编: 323000

E-mail: smrshiling01@163.com

Http://www.smrshiling.com

| | | |
|-----|-----|----|
| 拟制 | 审核 | 核准 |
| 林益龙 | 曹剑龙 | 宗瑞 |

| SYMBOL | CHARACTERISTIC | TEST CONDITIONS | T _j (°C) | VALUE | | | UNIT |
|----------------------|--|---|---------------------|-------|------|-------|----------------------------------|
| | | | | Min | Type | Max | |
| I _o | DC output current | Three-phase full wave rectifying circuit, T _c =100 °C | 150 | | | 50 | A |
| V _{RRM} | Repetitive peak reverse voltage | V _{RRM} tp=10ms V _{RSM} = V _{DRM} &V _{RRM} +200V | 150 | 600 | | 2200 | V |
| I _{RRM} | Repetitive peak current | at V _{RRM} | 150 | | | 8 | mA |
| I _{FSM} | Surge forward current | 10ms half sine wave | 150 | | | 0.8 | KA |
| I ² t | I ² T for fusing coordination | V _R =0.6V _{RRM} | | | | 3.2 | A ² s*10 ³ |
| V _{FO} | Threshold voltage | | 150 | | | 0.80 | V |
| r _F | Forward slop resistance | | | | | 7.0 | mΩ |
| V _{FM} | Peak for ward voltage | I _{FM} =50A | 25 | | | 1.1 | V |
| R _{th(j-c)} | Thermal resistance Junction to heatsink | Single side cooled | | | | 0.320 | °C /W |
| V _{iso} | Isolation voltage | 50Hz, RM. S, t=1min, I _{iso} : 1mA (max) | | 2500 | | | V |
| F _m | Terminal connection torque (M5) | | | | 4.0 | | N.m |
| | Mounting torque (M6) | | | | 5.0 | | N.m |
| T _{stg} | Stored temperature | | | -40 | | 125 | °C |
| W _t | Weight | | | | 154 | | g |
| Outline | | | | | | | |

OUTLINE DRAWING & CIRCUIT DIAGRAM

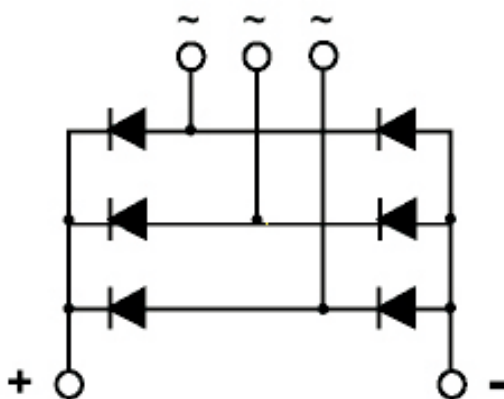

Rating and Characteristic

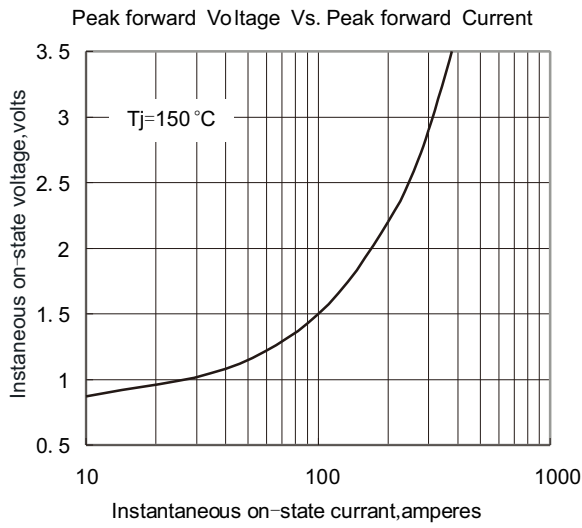

Fig. 1

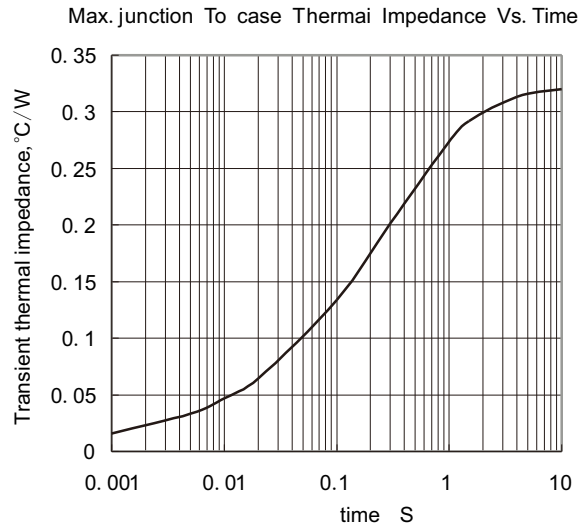

Fig. 2

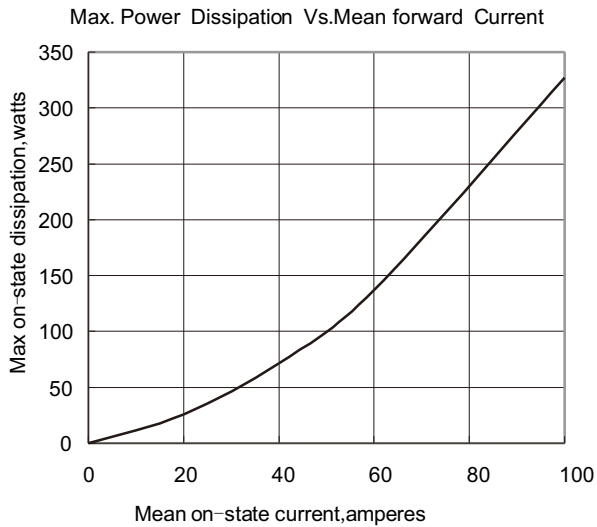

Fig. 3

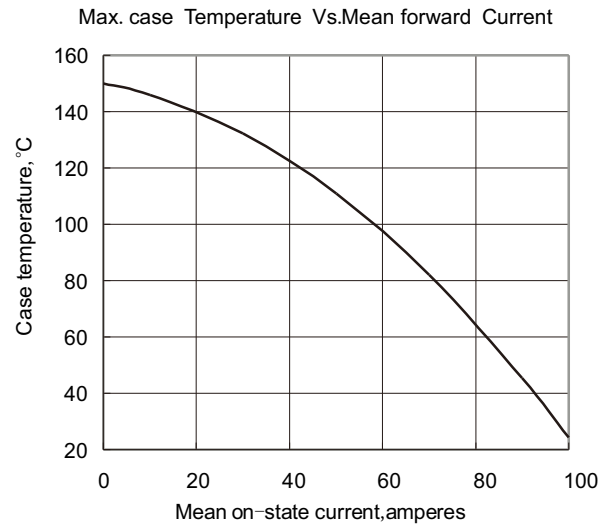

Fig. 4

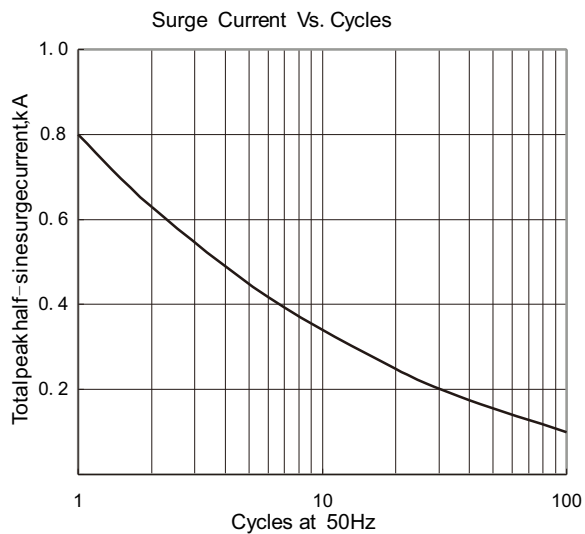

Fig. 5

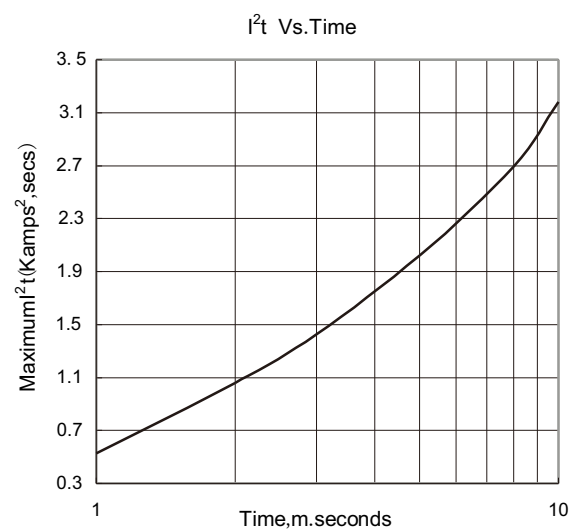

Fig. 6

Outside Dimension

