

产品规格书

Specification of products

产品名称:可控硅模块

产品型号: MFC60A-T20

浙江世菱半导体有限公司
ZHEJIANG SHILING SEMICONDUCTOR CO., LTD.

地址: 浙江省 丽水市 莲都区

电话: (0578) 3012571 3615078

传真: (0578) 3611180

邮编: 323000

E-mail: smrshiling01@163.com

Http://www.smrshiling.com

拟制	审核	核准
林益龙	曹剑龙	宗瑞

SYMBOL	CHARACTERISTIC	TEST CONDITIONS	T _j (°C)	VALUE			UNIT
				Min	Type	Max	
I _{T(AV)} I _{F(AV)}	Mean on-state current	180° half sine wave 50Hz Single side cooled, T _c =85°C	125			60	A
I _{T(RMS)}	RMS on-state current	Single side cooled, T _c =85°C	125			195	A
V _{DRM} V _{RRM}	Repetitive peak off-state voltage Repetitive peak reverse voltage	V _{DRM} &V _{RRM} tp=10ms V _{DSM} &V _{RSM} = V _{DRM} &V _{RRM} +200V respectively	125	600		1800	V
I _{DRM} I _{RRM}	Repetitive peak current	at V _{DRM} at V _{RRM}	125			10	mA
I _{TSM}	Surge on-state current	10ms half sine wave	125			1.60	KA
I ² t	I ² T for fusing coordination	V _R =60%V _{RRM}				13.0	A ² s*10 ³
V _{TO}	Threshold voltage		125			0.80	V
r _T	On-state slop resistance					2.64	mΩ
V _{TM}	Peak on-state voltage	I _{TM} =180A	125			1.4	V
dv/dt	Critical rate of rise of off-state voltage	V _{DM} =67%V _{DRM}	125			800	V/μs
di/dt	Critical rate of rise of on-state current	From 67%V _{DRM} to 210A, Gate source 1.5A t _r ≤ 0.5 μs Repetitive	125			50	A/μs
I _{GT}	Gate trigger current			20		100	mA
V _{GT}	Gate trigger voltage	V _A =12V, I _A =1A	25	0.7		2.0	V
I _H	Holding current			20		100	mA
T _q	Gate controlled turn off time	I _{TM} = I _o , V _D = 67%V _{DRM} , dv/dt=20 V/ us V _R = 100 V. -di/dt= 20 A/ us	125	90		110	us
V _{GD}	Non-trigger gate voltage	At 67%V _{DRM}	125			0.2	V
R _{th(j-c)}	Thermal resistance Junction to heatsink	At 180° sine Single side cooled				0.410	°C/W
V _{iso}	Isolation voltage	50Hz, RM. S, t=1min, I _{iso} : 1mA (MAX)		2500			V
F _m	Thermal connection torque(M5)					4.0	N.m
	Mounting torque(M6)					5.0	N.m
T _{stg}	Stored temperature			-40		140	°C
W _t	Weight					154	g
Outline							

OUTLINE DRAWING & CIRCUIT DIAGRAM

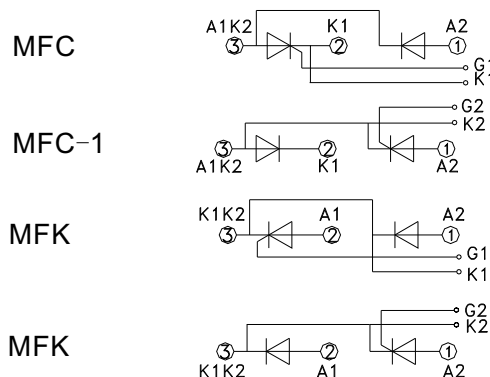

Rating and Characteristic

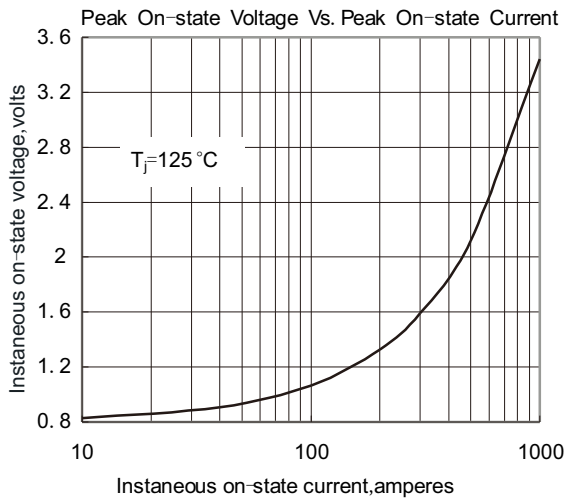

Fig. 1

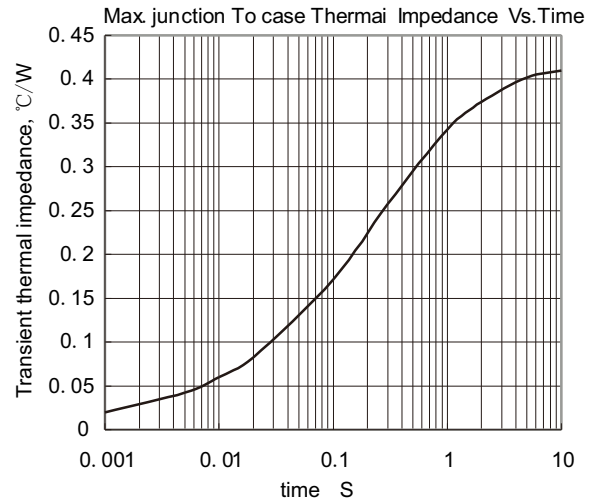

Fig. 2

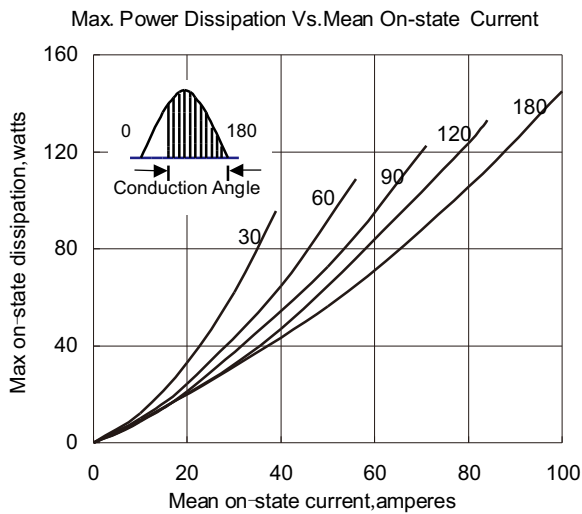

Fig. 3

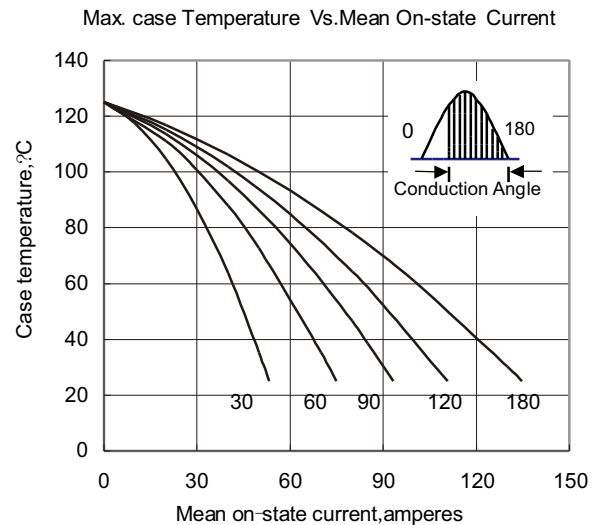

Fig. 4

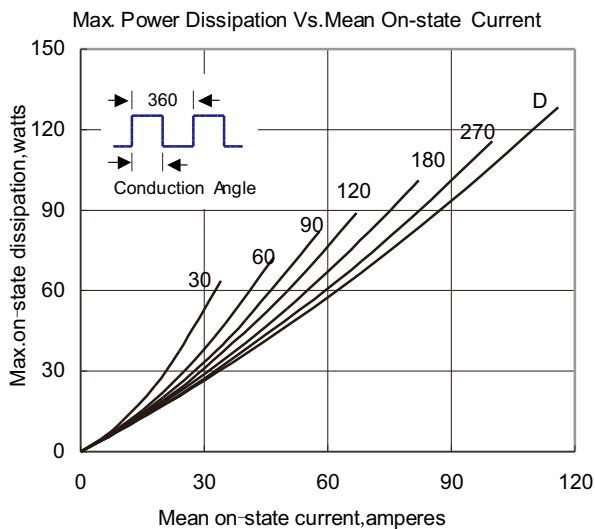

Fig. 5

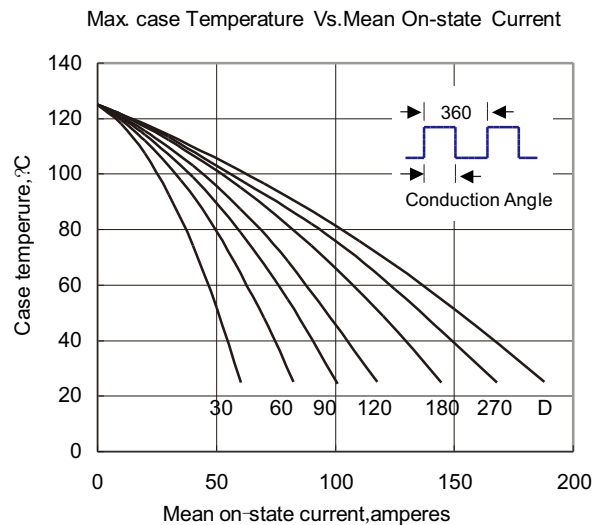

Fig. 6

Rating and Characteristic

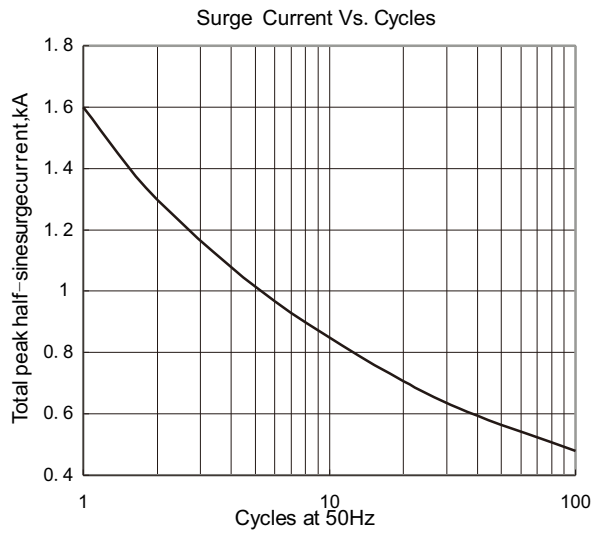

Fig. 7

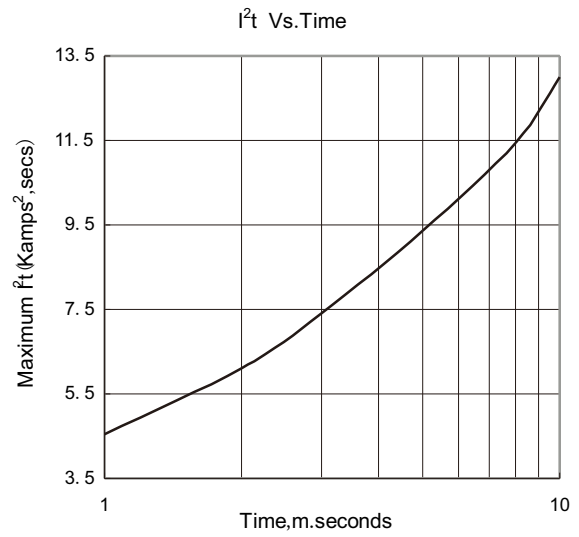

Fig. 8

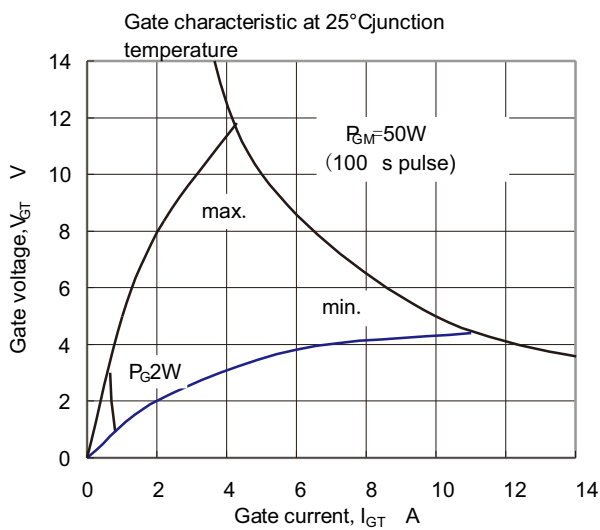

Fig. 9

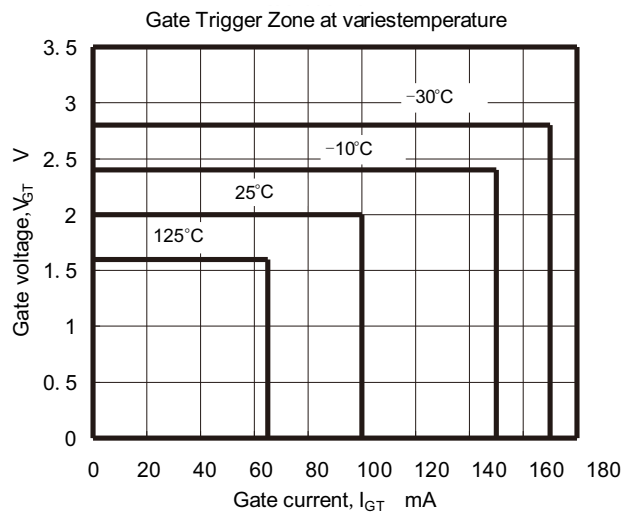

Fig. 10

Outside Dimension

