

## 产品规格书

### Specifcation of products

产品名称:可控硅模块

产品型号: MFC25A-T02

浙江世菱半导体有限公司  
ZHEJIANG SHILING SEMICONDUCTOR CO., LTD.

地址: 浙江省 丽水市 莲都区

电话: (0578) 3012571 3615078

传真: (0578) 3611180

邮编: 323000

E-mail: smrshiling01@163.com

Http://www.smrshiling.com

拟制	审核	核准
林益龙	曹剑龙	宗瑞

SYMBOL	CHARACTERISTIC	TEST CONDITIONS	T <sub>j</sub> (°C)	VALUE			UNIT
				Min	Type	Max	
I <sub>T(AV)</sub>	Mean on-state current	180° half sine wave 50Hz Single side cooled, T <sub>c</sub> =85°C	125			25	A
I <sub>T(RMS)</sub>	RMS on-state current	Single side cooled, T <sub>c</sub> =85°C	125			40	A
V <sub>DRM</sub> V <sub>RPM</sub>	Repetitive peak off-state voltage Repetitive peak reverse voltage	V <sub>DRM</sub> &V <sub>RPM</sub> tp=10ms V <sub>DSM</sub> &V <sub>RSM</sub> = V <sub>DRM</sub> &V <sub>RPM</sub> +200V respectively	125		1600	1800	V
I <sub>DRM</sub> I <sub>RPM</sub>	Repetitive peak current	at V <sub>DRM</sub> at V <sub>RPM</sub>	125			10	mA
I <sub>TSM</sub>	Surge on-state current	10ms half sine wave	125			0.48	KA
I <sup>2</sup> t	I <sup>2</sup> T for fusing coordination	V <sub>R</sub> =60%V <sub>RPM</sub>				1.5	A <sup>2</sup> s*10 <sup>3</sup>
V <sub>TO</sub>	Threshold voltage		125			0.90	V
r <sub>T</sub>	On-state slop resistance					12	mΩ
V <sub>TM</sub>	Peak on-state voltage	I <sub>TM</sub> =50A	25			1.40	V
V <sub>FM</sub>	Peak on-state voltage	I <sub>FM</sub> =50A	25			1.10	V
dv/dt	Critical rate of rise of off-state voltage	V <sub>DM</sub> =67%V <sub>DRM</sub>	125			1000	V/μs
di/dt	Critical rate of rise of on-state current	From 67%V <sub>DRM</sub> to 210A, Gate source 1.5A t <sub>r</sub> ≤ 0.5 μs Repetitive	125			110	A/μs
I <sub>GT</sub>	Gate trigger current		25	30		150	mA
V <sub>GT</sub>	Gate trigger voltage	V <sub>A</sub> =12V, I <sub>A</sub> =1A		0.8		1.8	V
I <sub>H</sub>	Holding current			20		100	mA
V <sub>GD</sub>	Non-trigger gate voltage	At 67%V <sub>DRM</sub>	125			0.25	V
R <sub>th(j-c)</sub>	Thermal resistance Junction to heatsink	At 180° sine Single side cooled				0.280	°C/W
V <sub>iso</sub>	Isolation voltage	50Hz, RM. S, t=1min, I <sub>iso</sub> : 1mA (MAX)		2500			V
F <sub>m</sub>	Thermal connection torque( M5)				4.0		N.m
	Mounting torque( M6)				5.0		N.m
T <sub>stg</sub>	Stored temperature			-40		150	°C
W <sub>t</sub>	Weight				122		g
Outline							

### OUTLINE DRAWING & CIRCUIT DIAGRAM

MFC (TD)

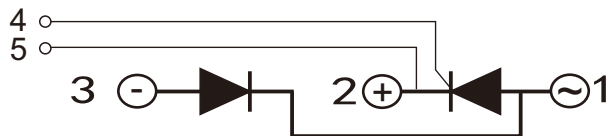

MFC (DT)

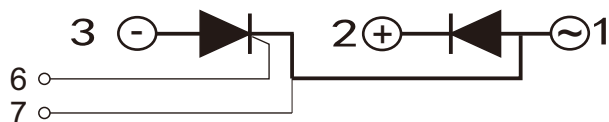

### Rating and Characteristic

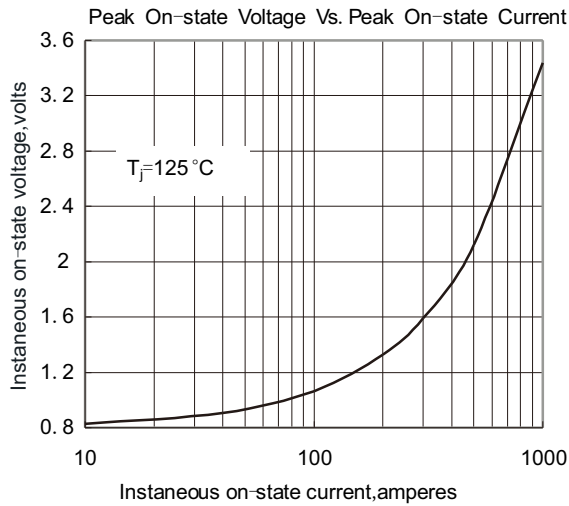

Fig. 1

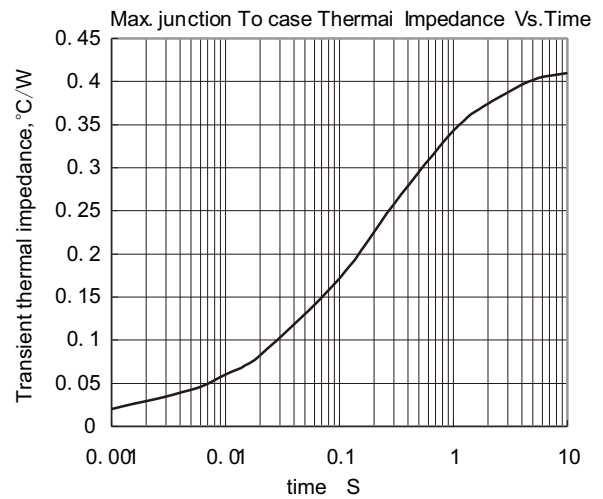

Fig. 2

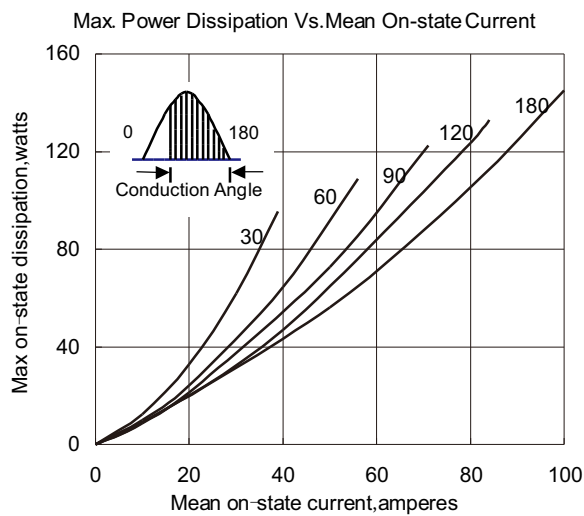

Fig. 3

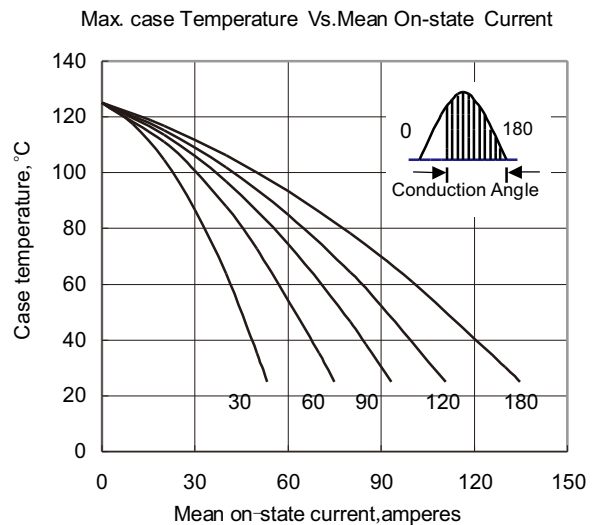

Fig. 4

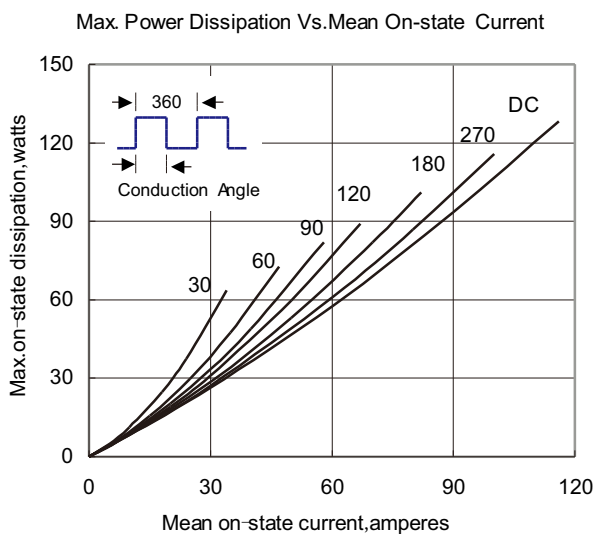

Fig. 5

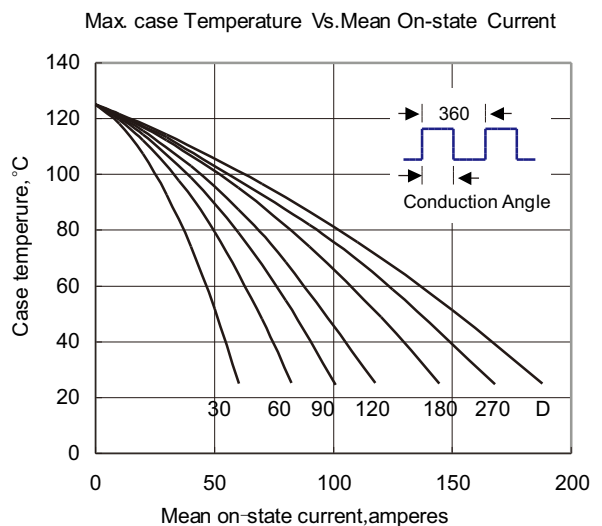

Fig. 6

### Rating and Characteristic

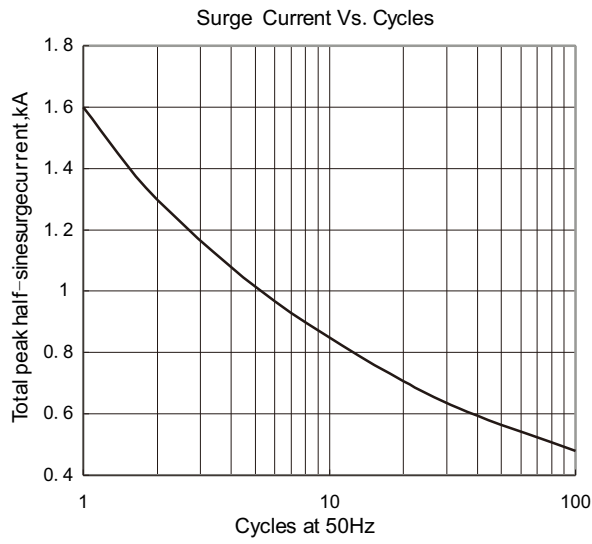

Fig. 7

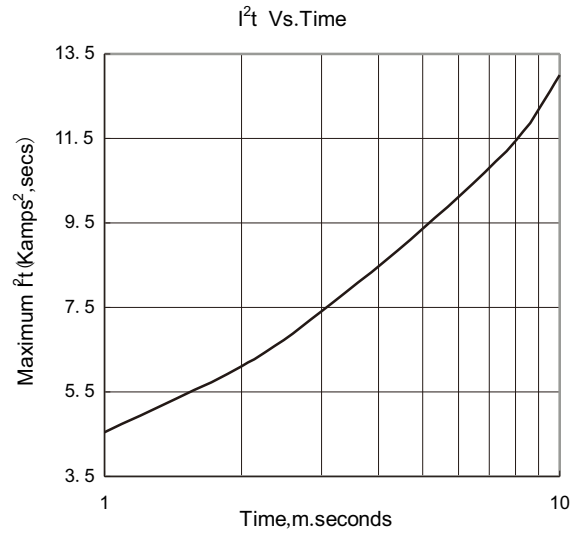

Fig. 8

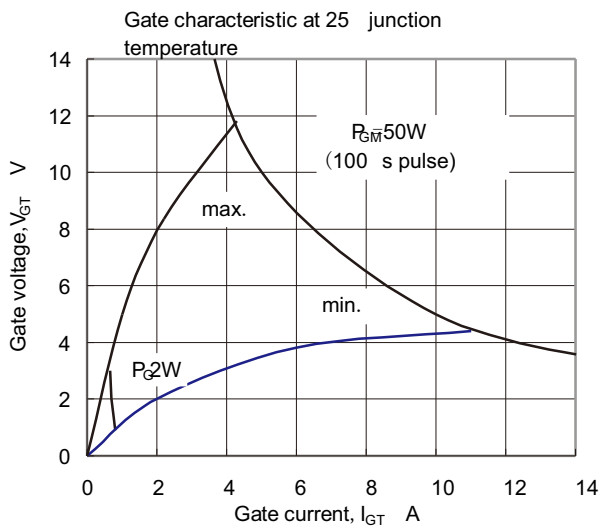

Fig. 9

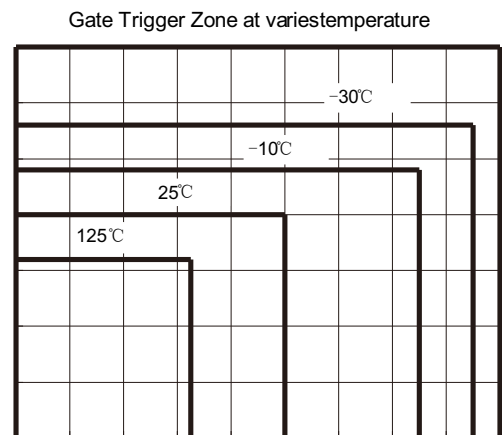

Fig. 10

## Outside Dimension

