

## 产品规格书

### Specification of products

产品名称: 快恢复二极管

产品型号: MF2X100U6NK5

浙江世菱半导体有限公司  
ZHEJIANG SHILING SEMICONDUCTOR CO., LTD.

地址: 浙江省 丽水市 莲都区

电话: (0578) 3012571 3615078

传真: (0578) 3611180

邮编: 323000

E-mail: smrshiling01@163.com

Http://www.smrshiling.com

拟制	审核	核准
林益龙	曹剑龙	宗瑞

### PRODUCT FEATURES

- Ultrafast Reverse Recovery Time
- Soft Reverse Recovery Characteristics
- Low Reverse Recovery Loss
- High System Power Density
- Popular SOT-227 Package



### APPLICATIONS

- Inversion Welder
- Uninterruptible Power Supply (UPS)
- Plating Power Supply
- Ultrasonic Cleaner and Welder
- Converter & Chopper
- Power Factor Correction (PFC) Circuit

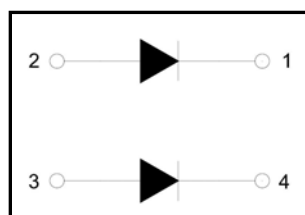

### ABSOLUTE MAXIMUM RATINGS

$T_C=25^{\circ}\text{C}$  unless otherwise specified

Symbol	Parameter	Test Conditions	Values	Unit
$V_R$	Maximum D.C. Reverse Voltage		600	V
$V_{RRM}$	Maximum Repetitive Reverse Voltage		600	V
$I_{F(AV)}$	Average Forward Current	$T_C=90^{\circ}\text{C}$ , Per Diode	100	A
		$T_C=90^{\circ}\text{C}$ , Per Mouldle	200	A
		$T_C=100^{\circ}\text{C}$ , 20KHz, Per Mouldle	150	A
$I_{F(RMS)}$	RMS Forward Current	$T_C=90^{\circ}\text{C}$ , Per Diode	150	A
$I_{FSM}$	Non-Repetitive Surge Forward Current	1/2 Cycle, 50Hz, Sine	1500	A
		1/2 Cycle, 60Hz, Sine	1800	A
$I^2t$	$I^2t$ (For Fusing)	$T_J=45^{\circ}\text{C}$ , $t=10\text{ms}$ , 50Hz, Sine	11250	$\text{A}^2\text{s}$
		$T_J=45^{\circ}\text{C}$ , $t=8.3\text{ms}$ , 60Hz, Sine	16200	$\text{A}^2\text{s}$
$P_D$	Power Dissipation		417	W
$T_J$	Junction Temperature		-40 to +150	$^{\circ}\text{C}$
$T_{STG}$	Storage Temperature Range		-40 to +125	$^{\circ}\text{C}$
$V_{isol}$	Insulation Test Voltage	AC, $t=1\text{min}$	3000	V
Torque	To-Sink	Recommended (M4)	0.7~1.1	N.m
Torque	To-Terminal	Recommended (M4)	0.7~1.1	N.m
$R_{\theta C}$	Thermal Resistance	Junction-to-Case	0.30	$^{\circ}\text{C} / \text{W}$
Weight			26.5	g

### ELECTRICAL CHARACTERISTICS

$T_C=25^\circ\text{C}$  unless otherwise specified

Symbol	Parameter	Test Conditions	Min.	Typ.	Max.	Unit
$I_{RM}$	Reverse Leakage Current	$V_R=600\text{V}$	--	--	1	mA
		$V_R=600\text{V}, T_J=125^\circ\text{C}$	--	--	5	mA
$V_F$	Forward Voltage	$I_F=100\text{A}$	--	1.2	1.45	V
		$I_F=100\text{A}, T_J=125^\circ\text{C}$	--	1.1	1.35	V
$t_{rr}$	Reverse Recovery Time	$I_F=1\text{A}, V_R=30\text{V}, di_F/dt=-200\text{A}/\mu\text{s}$	--	50	--	ns
$t_{rr}$	Reverse Recovery Time	$V_R=300\text{V}, I_F=100\text{A}$	--	115	--	ns
$I_{RRM}$	Max. Reverse Recovery Current	$di_F/dt=-200\text{A}/\mu\text{s}, T_J=25^\circ\text{C}$	--	1.35	--	A
$t_{rr}$	Reverse Recovery Time	$V_R=300\text{V}, I_F=100\text{A}$	--	190	--	ns
$I_{RRM}$	Max. Reverse Recovery Current	$di_F/dt=-200\text{A}/\mu\text{s}, T_J=125^\circ\text{C}$	--	19	--	A

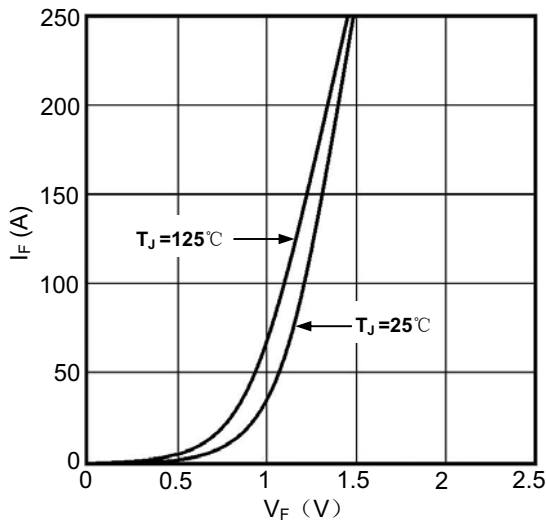

Figure1. Forward Voltage Drop vs Forward Current

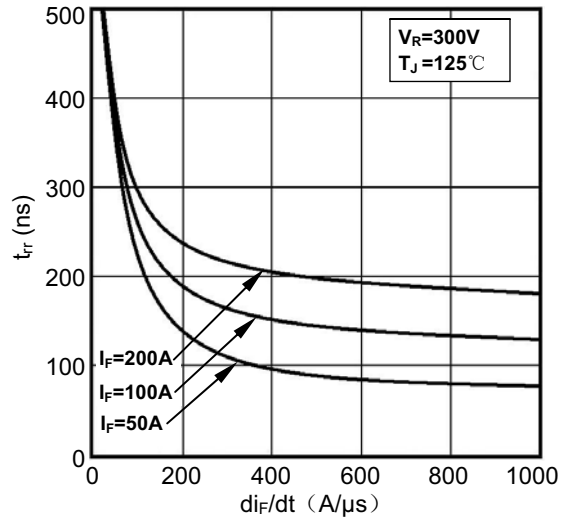

Figure2. Reverse Recovery Time vs  $di_F/dt$

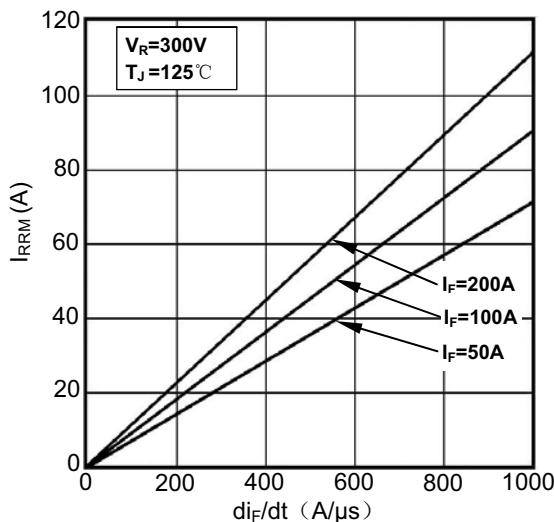

Figure3. Reverse Recovery Current vs  $di_F/dt$

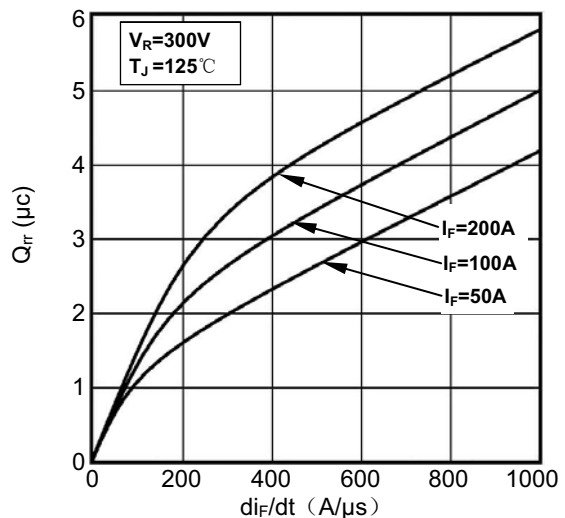

Figure4. Reverse Recovery Charge vs  $di_F/dt$

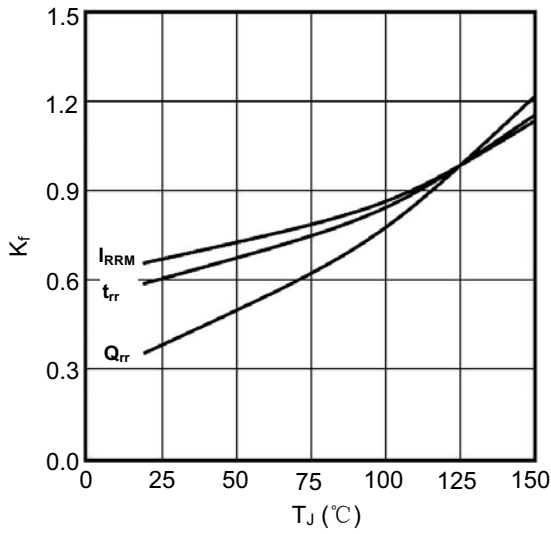

Figure5. Dynamic Parameters vs Junction Temperature

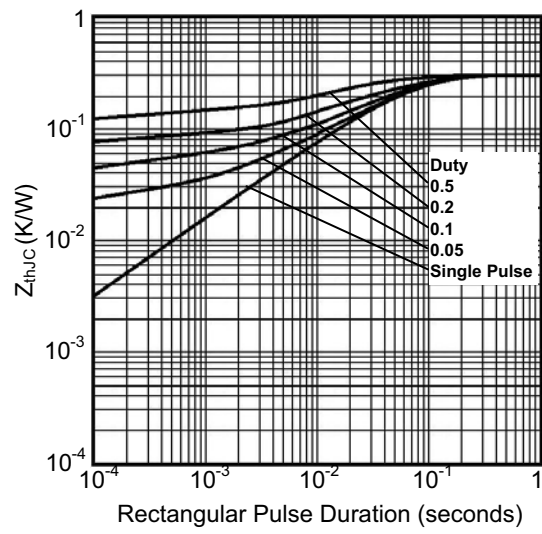
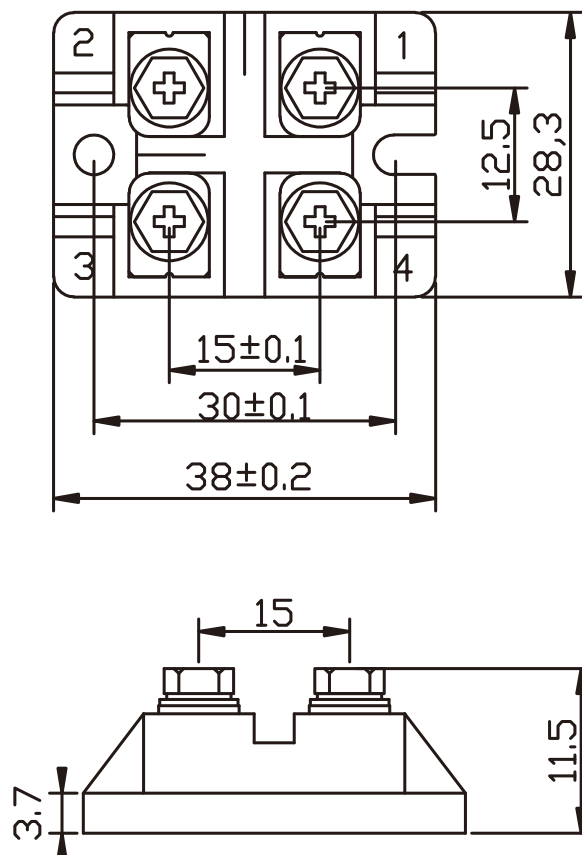

Figure6. Transient Thermal Impedance

## Package Outline



Dimensions (mm)