

## 产品规格书

### Specification of Products

产品名称：MOSFET模块

产品型号：340A100V

浙江世菱电力电子有限公司

ZHEJIANG SHILING POWER ELECTRON CO.,LTD.

厂址：浙江省 缙云县 五东工业区

电话：（0578）3012571 3615078

传真：（0578）3611180

邮编：321400

E-mail: smrshiling01@163.com

Http://www.smrshiling.com

拟制	审核	核准
金明辉	曹剑龙	宗瑞

SEMICONDUCTOR

## MOSFET

### Molding Type Module

100V/340A 2 in one-package



### General Description

SHILINGPOWER MOSFET Power Module provides very low  $R_{DS(on)}$  as well as optimized intrinsic diode. It is designed for the applications such as SMPS and DC drives.

### Features

- Low  $R_{DS(on)}$
- Optimized intrinsic reverse diode
- Low inductance case avoid oscillations
- Kelvin source terminals for easy drive
- Isolated copper baseplate using DBC technology

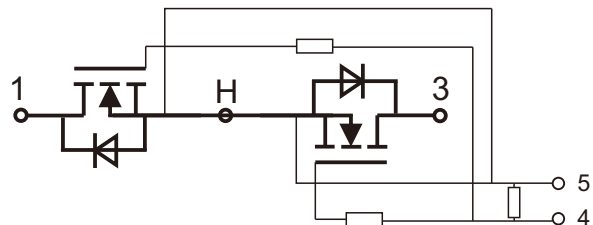

Equivalent Circuit Schematic

### Typical Applications

- Main and auxiliary AC drives of electric vehicles
- DC servo and robot drives
- Battery vehicles
- UPS equipment
- Plasma cutting

## Absolute Maximum Ratings $T_C=25^\circ\text{C}$ unless otherwise noted

Symbol	Description		Units
$V_{DSS}$	Drain-Source Voltage	100	V
$V_{GSS}$	Gate-Source Voltage	$\pm 30$	V
$I_D$	Drain Current @ $T_C=25^\circ\text{C}$ @ $T_C=100^\circ\text{C}$	340 240	A
$I_F$	Diode Forward Current	340	A
$P_D$	Maximum Power Dissipation @ $T_j=175^\circ\text{C}$	754	W
$T_{jmax}$	Maximum Junction Temperature	175	$^\circ\text{C}$
$T_{pp}$	Operating Junction Temperature	- 40 to +150	$^\circ\text{C}$
$T_{STG}$	Storage Temperature Range	- 40 to +125	$^\circ\text{C}$
$V_{ISO}$	Isolation Voltage RMS, $f=50\text{Hz}, t=1\text{min}$	3000	V
Mounting Torque	Power Terminal Screw:M5 Mounting Screw:M6	3.5to 4.0 3.0 to 5.0	N.m

## Electrical Characteristics of MOSFET $T_C=25^\circ\text{C}$ unless otherwise noted

### Off Characteristics

Symbol	Parameter	Test Conditions	Min.	Typ.	Max.	Units
$V_{(BR)DSS}$	Drain-Source Breakdown Voltage	$T_j=25^\circ\text{C}$	100			V
$I_{DSS}$	Drain-Source Leakage Current	$V_{DS}=V_{DSS}, V_{GS}=0\text{V}, T_j=25^\circ\text{C}$			40	$\mu\text{A}$
$I_{GSS}$	Gate-Source Leakage Current	$V_{GS}=V_{GSS}, V_{DS}=0\text{V}, T_j=25^\circ\text{C}$			200	nA

### On Characteristics

Symbol	Parameter	Test Conditions	Min.	Typ.	Max.	Units
$V_{GS(th)}$	Gate-Source Threshold Voltage	$I_D=0.5\text{mA}, V_{DS}=V_{GS}, T_j=25^\circ\text{C}$	3.0		5.0	V
$R_{DS(on)}$	Static Drain-Source On-Resistance	$I_D=206\text{A}, V_{GS}=10\text{V}, T_j=25^\circ\text{C}$			2.95	$\Omega\text{m}$
$g_{fs}$	Forward Transconductance	$V_{DS}=50\text{V}, I_D=206\text{A}$	324			S

## Switching Characteristics

Symbol	Parameter	Test Conditions	Min.	Typ.	Max.	Units
$R_{Gint}$	Internal Gate Resistance			1.35		$\Omega$
$t_{d(on)}$	Turn-On Delay Time	$V_{DD}=50V, I_D=206A,$ $R_G=0.5\Omega, V_{GS}=10V,$ $T_j=25^\circ C$		27		ns
$t_r$	Rise Time			119		ns
$t_{d(off)}$	Turn-Off Delay Time			47		ns
$t_f$	Fall Time			84		ns
$Q_g$	Total Gate Charge	$I_D=206A, V_{DS}=80V,$ $V_{GS}=10V$		302		nC
$Q_{gs}$	Gate-Source Charge			104		nC
$Q_{gd}$	Gate-Drain ("Miller") Charge			110		nC
$C_{iss}$	Input Capacitance	$V_{GS}=0V, V_{DS}=25V,$ $f=1.0MHz$		20.9		nF
$C_{oss}$	Output Capacitance			1.95		nF
$C_{rss}$	Reverse Transfer Capacitance			0.41		nF
$L_{CE}$	Stray Inductance				22	nH
$R_{CC+EE}$	Module Lead Resistance, Terminal to Chip	$T_C=25^\circ C$		0.65		m $\Omega$

## Electrical Characteristics of Inverse Diode $T_C=25^\circ C$ unless otherwise

noted

Symbol	Parameter	Test Conditions	Min.	Typ.	Max.	Units
$V_{SD}$	Diode Forward Voltage	$I_F=206A, V_{GS}=0V, T_j=25^\circ C$			1.30	V
$t_{rr}$	Diode Reverse Recovery Time	$V_R=50V, I_F=206A,$ $di/dt=200A/\mu s, T_j=25^\circ C$		110		ns
$Q_{rr}$	Diode Reverse Recovery Charge			1.03		$\mu C$

## Thermal Characteristics

Symbol	Parameter	Typ.	Max.	Units
$R_{\theta JC}$	Junction-to-Case (per MOSFET)		0.199	K/W
$R_{\theta CS}$	Case-to-Sink (Conductive grease applied)	0.035		K/W
Weight	Weight of Module	115		g

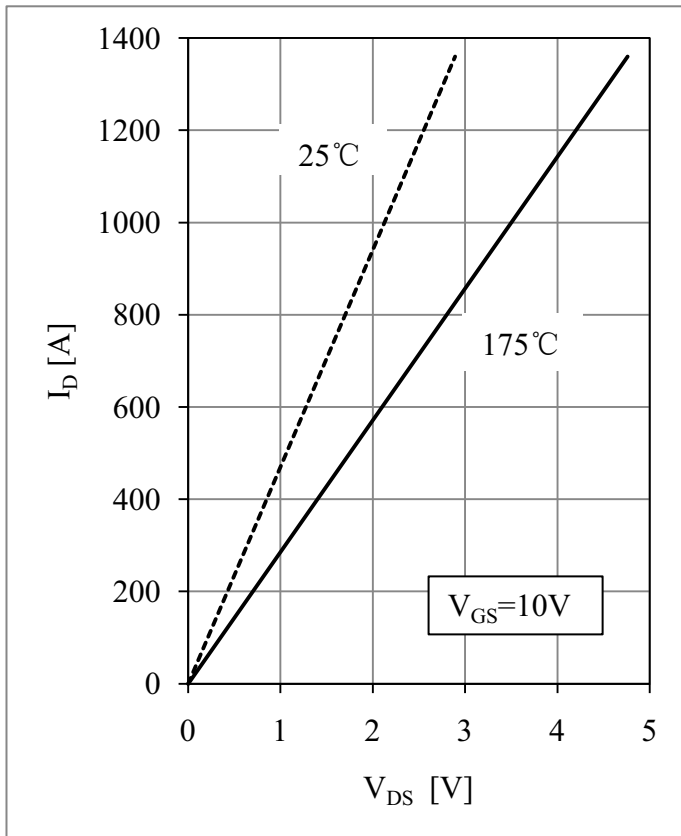

Fig 1. Mosfet Output Characteristic

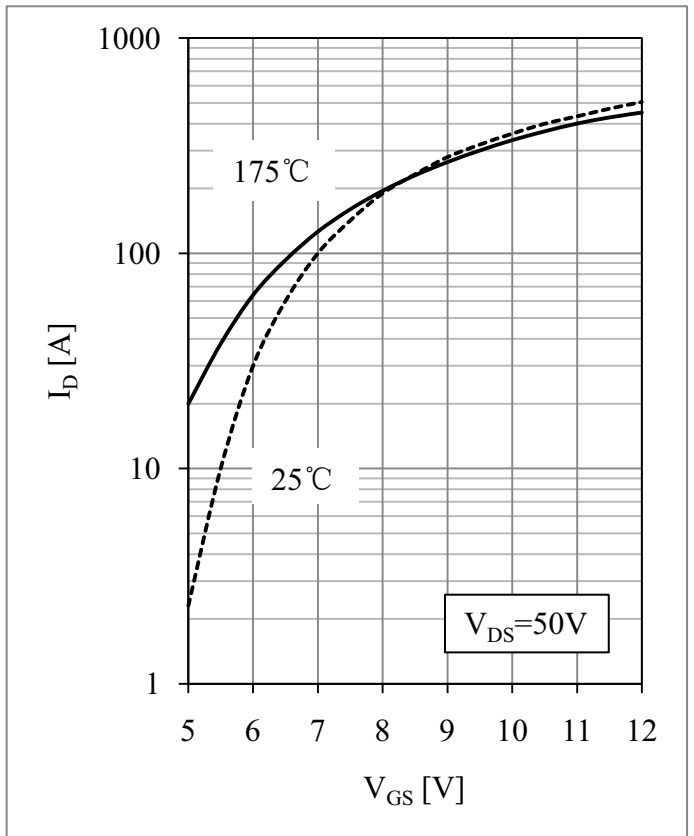

Fig 2. Mosfet Transfer Characteristic

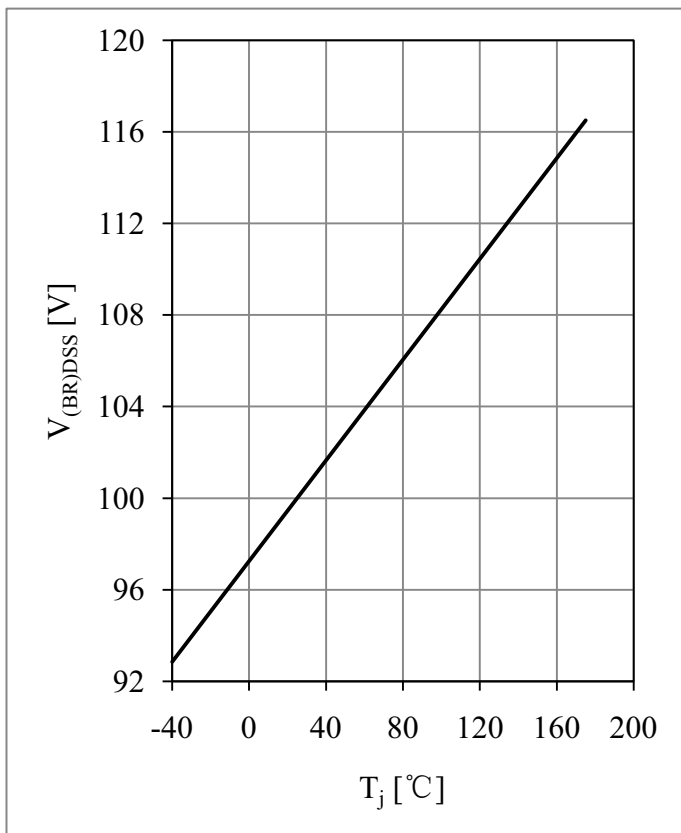

Fig 3. Brakedown Voltage vs. Temperature

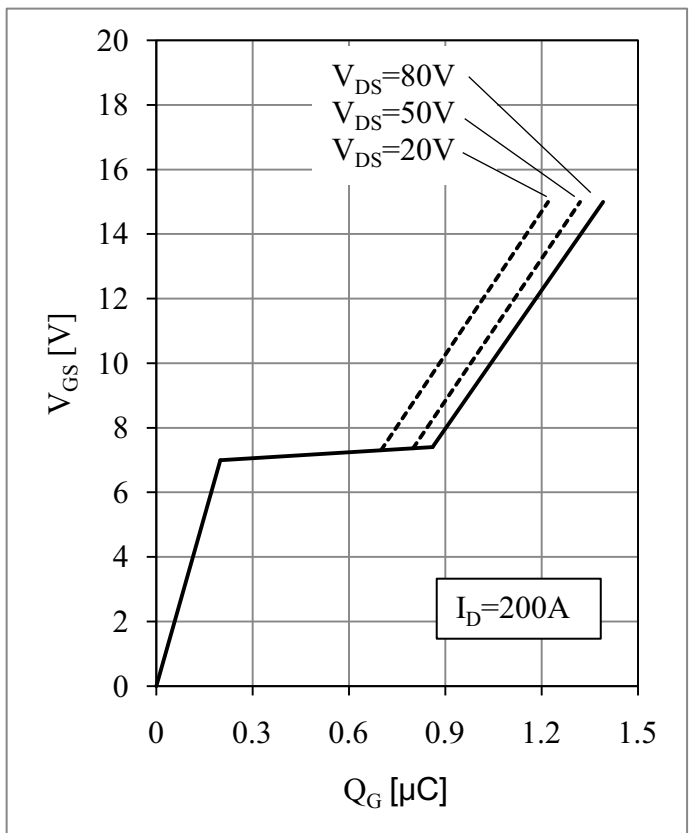

Fig 4. Gate Charge Characteristic

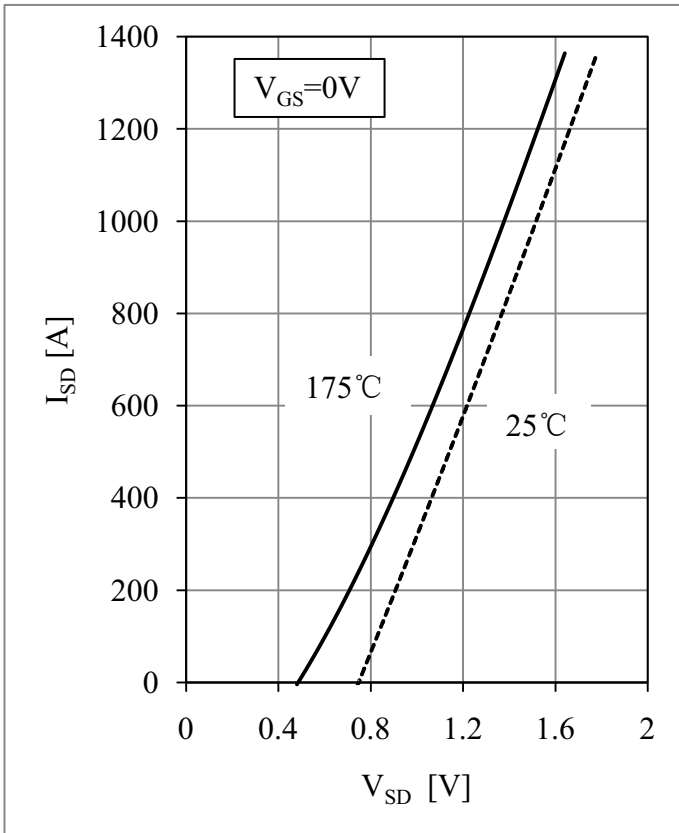

Fig 5. Inverse Diode Output Characteristic

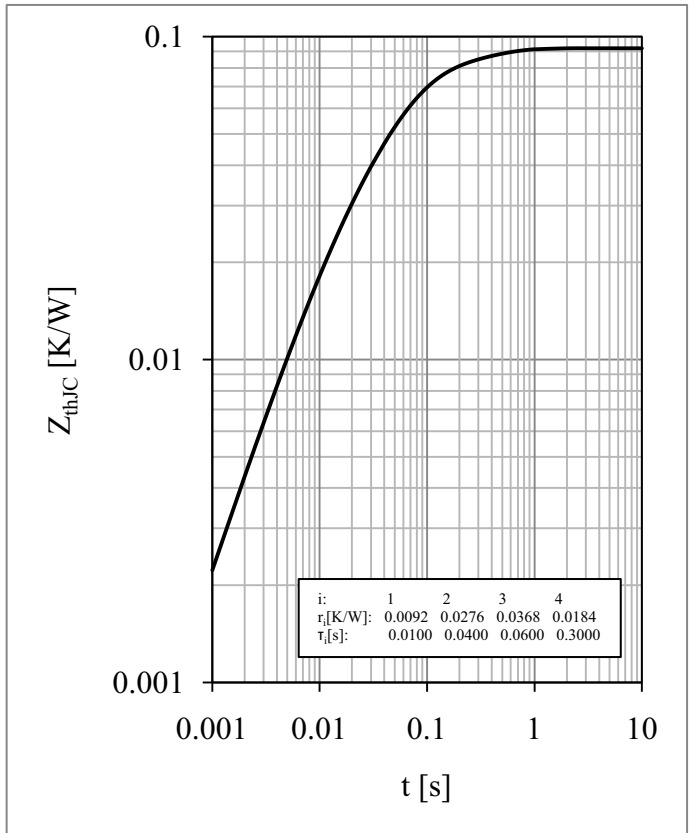
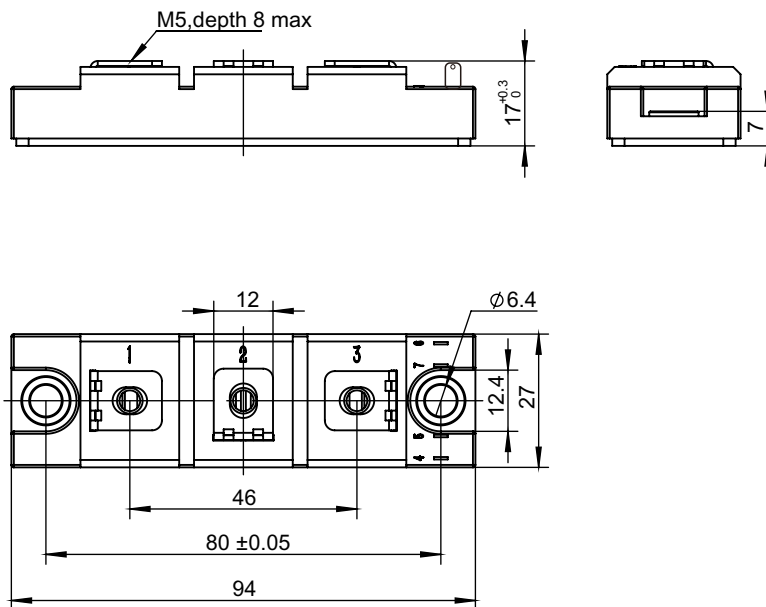

Fig 6. Transient Thermal Impedance

## Package Dimension



Dimensions (mm)