

产品规格书

Specification of Products

产品名称：MOSFET模块

产品型号：100A650V

浙江世菱电力电子有限公司

ZHEJIANG SHILING POWER ELECTRON CO.,LTD.

厂址：浙江省 缙云县 五东工业区

电话：（0578）3012571 3615078

传真：（0578）3611180

邮编：321400

E-mail:smrshiling01@163.com

Http://www.smrshiling.com

拟制	审核	核准
金明辉	曹剑龙	宗瑞

SEMICONDUCTOR

MOSFET

Molding Type Module

650V/100A 2 in one-package

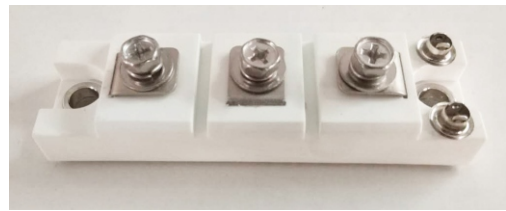

General Description

SHILINGPOWER MOSFET Power Module provides very low $R_{DS(on)}$ as well as optimized intrinsic diode. It is designed for the applications such as SMPS and DC drives.

Features

- Low $R_{DS(on)}$
- Optimized intrinsic reverse diode
- Low inductance case avoid oscillations
- Kelvin source terminals for easy drive
- Isolated copper baseplate using DBC technology

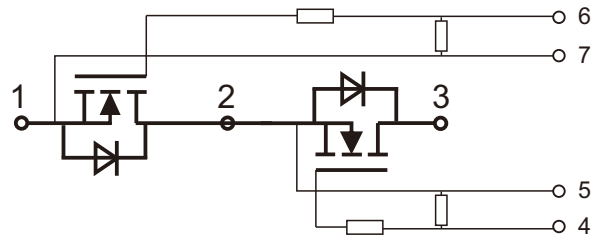

Equivalent Circuit Schematic

Typical Applications

- Main and auxiliary AC drives of electric vehicles
- DC servo and robot drives
- Battery vehicles
- UPS equipment
- Plasma cutting

Absolute Maximum Ratings $T_C=25^\circ\text{C}$ unless otherwise noted

Symbol	Description		Units
V_{DSS}	Drain-Source Voltage	650	V
V_{GSS}	Gate-Source Voltage	± 30	V
I_D	Drain Current @ $T_C=25^\circ\text{C}$ @ $T_C=80^\circ\text{C}$	100 80	A
I_F	Diode Forward Current	100	A
P_D	Maximum Power Dissipation @ $T_j=175^\circ\text{C}$	720	W
T_{jmax}	Maximum Junction Temperature	150	$^\circ\text{C}$
T_{pp}	Operating Junction Temperature	- 40 to +150	$^\circ\text{C}$
T_{STG}	Storage Temperature Range	- 40 to +125	$^\circ\text{C}$
V_{ISO}	Isolation Voltage RMS, $f=50\text{Hz}$, $t=1\text{min}$	3000	V
Mounting Torque	Power Terminal Screw:M5 Mounting Screw:M6	3.5to 4.0 3.0 to 5.0	N.m

Electrical Characteristics of MOSFET $T_C=25^\circ\text{C}$ unless otherwise noted

Off Characteristics

Symbol	Parameter	Test Conditions	Min.	Typ.	Max.	Units
$V_{(BR)DSS}$	Drain-Source Breakdown Voltage	$T_j=25^\circ\text{C}$	650			V
I_{DSS}	Drain-Source Leakage Current	$V_{DS}=V_{DSS}$, $V_{GS}=0\text{V}$, $T_j=25^\circ\text{C}$			1	μA
I_{GSS}	Gate-Source Leakage Current	$V_{GS}=V_{GSS}$, $V_{DS}=0\text{V}$, $T_j=25^\circ\text{C}$			± 100	nA

On Characteristics

Symbol	Parameter	Test Conditions	Min.	Typ.	Max.	Units
$V_{GS(th)}$	Gate-Source Threshold Voltage	$I_D=1.0\text{mA}$, $V_{DS}=V_{GS}$, $T_j=25^\circ\text{C}$	3.2		4.2	V
$R_{DS(on)}$	Static Drain-Source On-Resistance	$I_D=20\text{A}$, $V_{GS}=10\text{V}$, $T_j=25^\circ\text{C}$		32	40	$\text{m}\Omega$
g_{fs}	Forward Transconductance	$V_{DS}=50\text{V}$, $I_D=100\text{A}$	208			S

Switching Characteristics

Symbol	Parameter	Test Conditions	Min.	Typ.	Max.	Units
R_{Gint}	Internal Gate Resistance			0.68		Ω
$t_{d(on)}$	Turn-On Delay Time	$V_{DD}=600V, I_D=100A,$ $R_G=0.26\Omega, V_{GS}=10V,$ $T_j=25^\circ C$		25		ns
t_r	Rise Time			27		ns
$t_{d(off)}$	Turn-Off Delay Time			70		ns
t_f	Fall Time			16		ns
Q_g	Total Gate Charge	$I_D=50 A, V_{DS}=600V,$ $V_{GS}=10V$		197		nC
Q_{gs}	Gate-Source Charge			70		nC
Q_{gd}	Gate-Drain ("Miller") Charge			64		nC
C_{iss}	Input Capacitance	$V_{GS}=0V, V_{DS}=25V,$ $f=1.0MHz$		12.7		nF
C_{oss}	Output Capacitance			1.28		nF
C_{rss}	Reverse Transfer Capacitance			0.12		nF
L_{CE}	Stray Inductance				20	nH
R_{CC+EE}	Module Lead Resistance, Terminal to Chip	$T_C=25^\circ C$		0.35		m Ω

Electrical Characteristics of Inverse Diode $T_C=25^\circ C$ unless otherwise

noted

Symbol	Parameter	Test Conditions	Min.	Typ.	Max.	Units
V_{SD}	Diode Forward Voltage	$I_F=100A, V_{GS}=0V, T_j=25^\circ C$	0.5		1.0	V
t_{rr}	Diode Reverse Recovery Time	$V_R=300V, I_F=100A,$ $di/dt=100A/\mu s, T_j=25^\circ C$		200		ns
Q_{rr}	Diode Reverse Recovery Charge				0.6	

Thermal Characteristics

Symbol	Parameter	Typ.	Max.	Units
$R_{\theta JC}$	Junction-to-Case (per MOSFET)		0.189	K/W
$R_{\theta CS}$	Case-to-Sink (Conductive grease applied)	0.035		K/W
Weight	Weight of Module	110		g

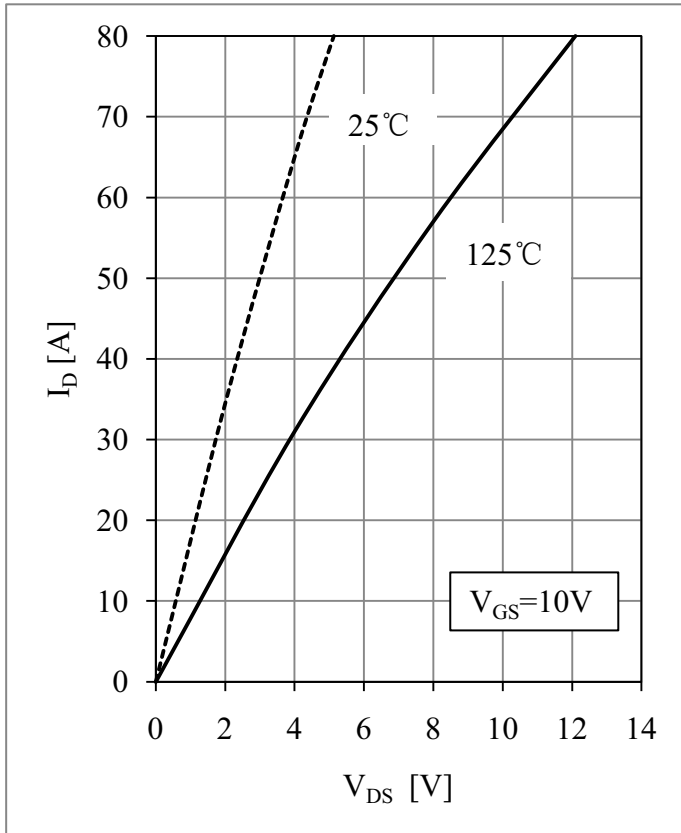

Fig 1. Mosfet Output Characteristics

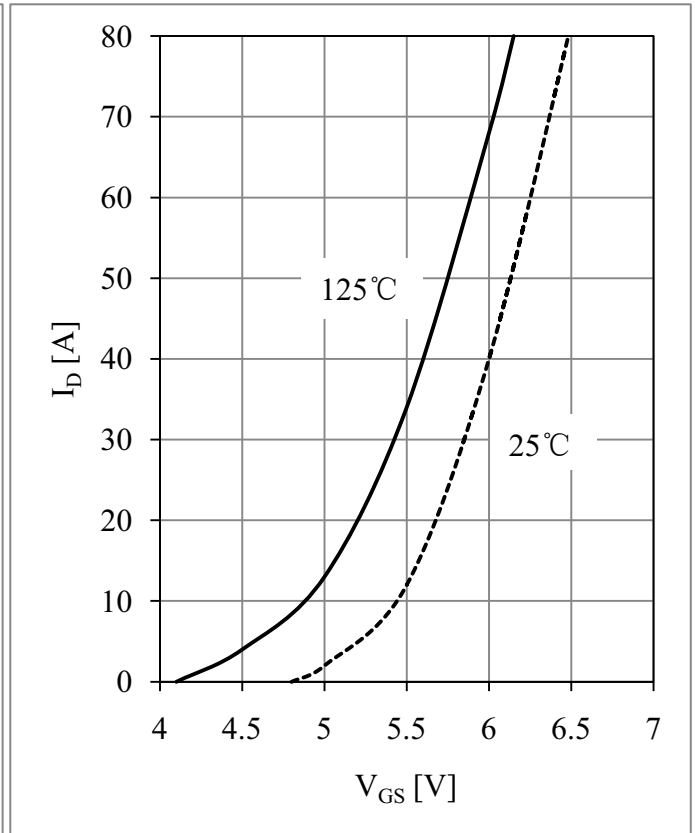

Fig 2. Mosfet Transfer Characteristics

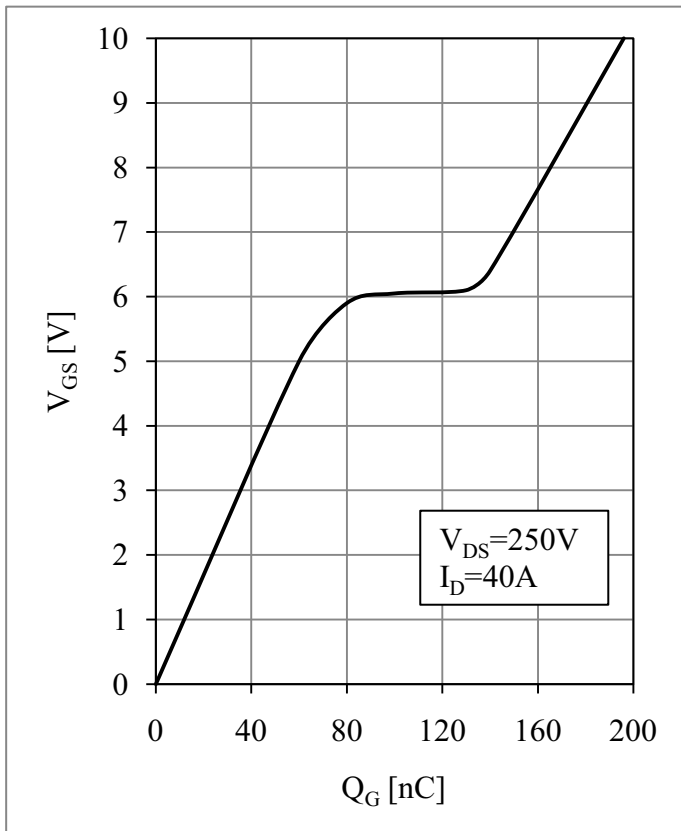

Fig 3. Gate Charge Characteristic

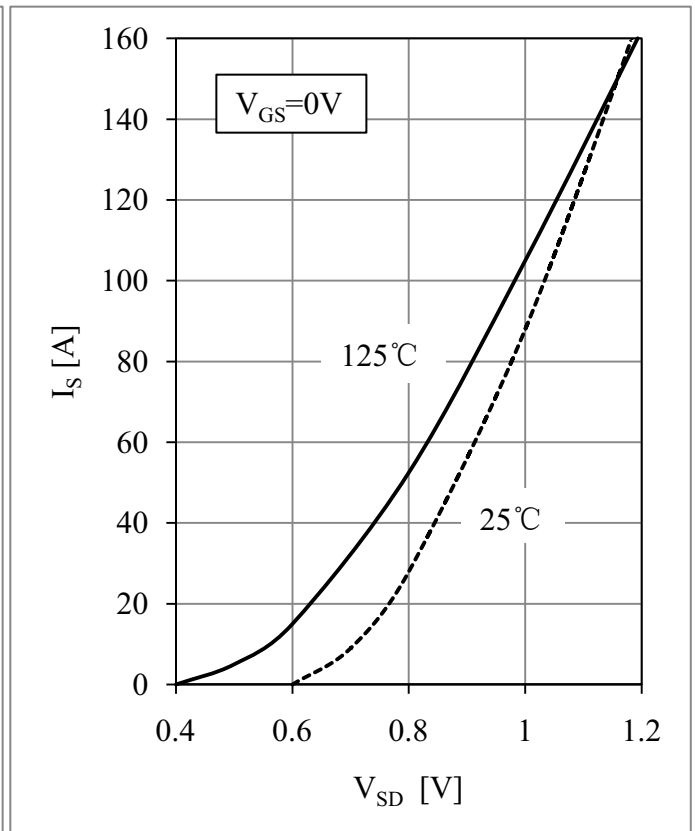

Fig 4. Inverse Diode Output Characteristics

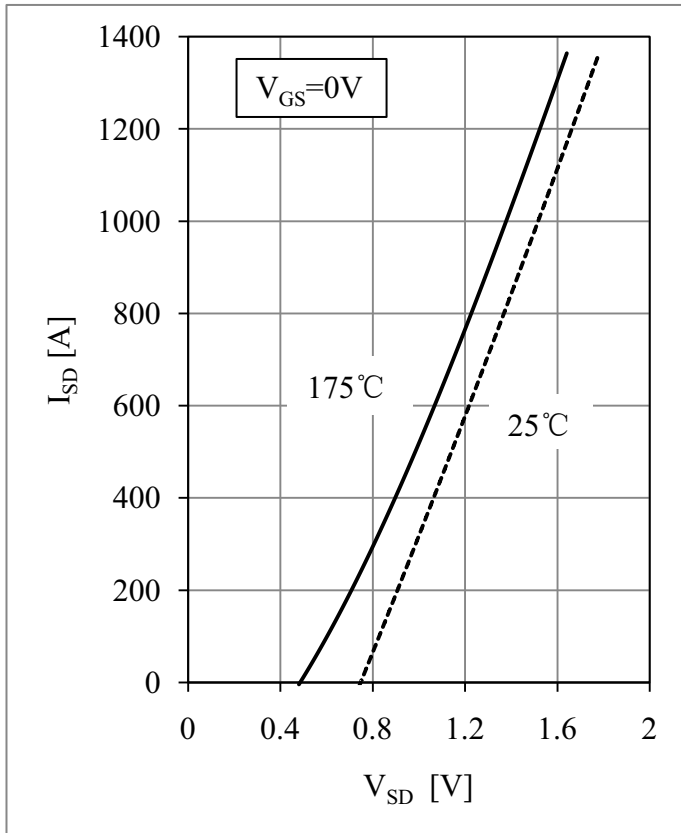

Fig 5. Inverse Diode Output Characteristic

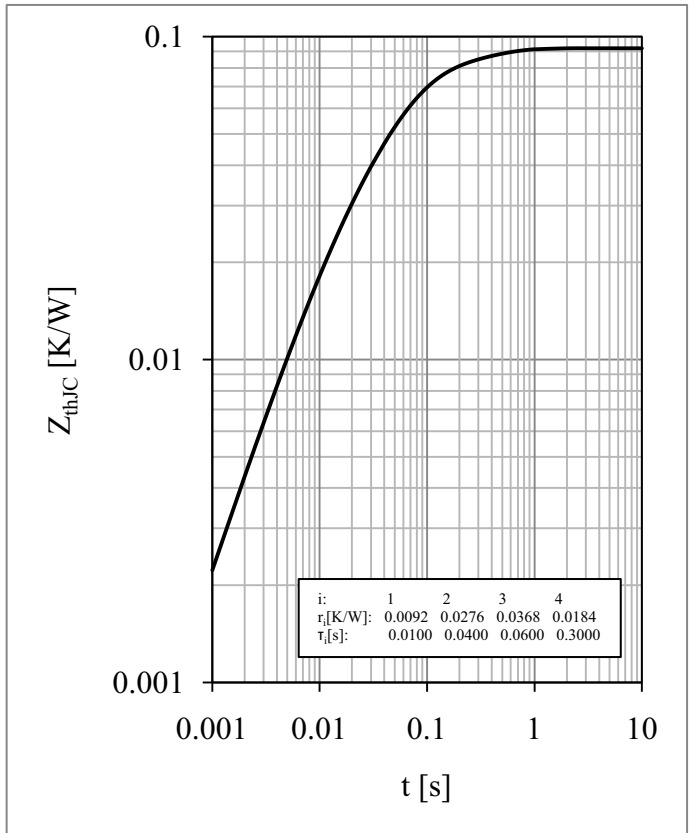
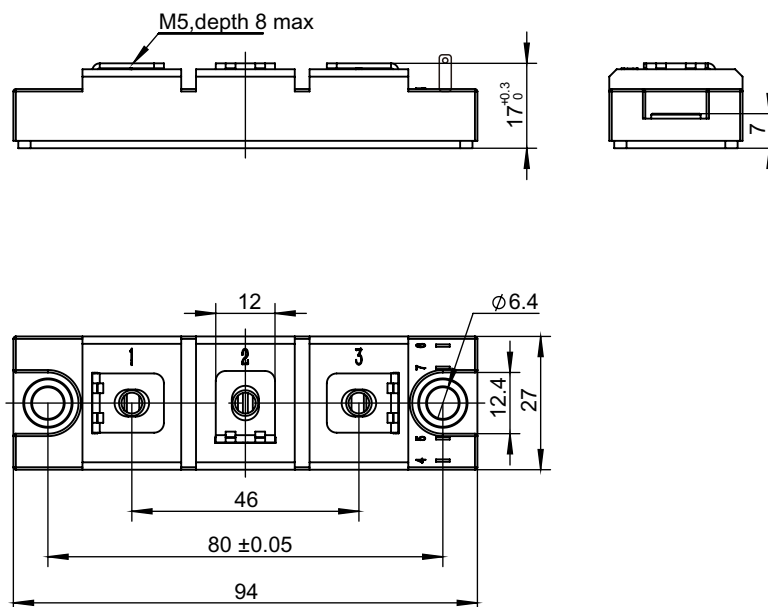

Fig 6. Transient Thermal Impedance

Package Dimension



Dimensions (mm)